



DOORS OF YOUR IMAGINATION



# SELECTED PROJECTS

Find out more: [www.drzwi-cal.pl](http://www.drzwi-cal.pl)



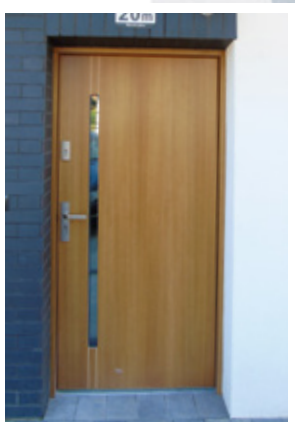

## SELECTED PROJECTS

Find out more: [www.drzwi-cal.pl](http://www.drzwi-cal.pl)

Dear Sirs,

It is a great honor and real pleasure for me as the owner of the CAL company - representing the best values of a family business - to present to you our offer that will make all your dreams of a beautiful wood, and yet technologically advanced door, come true. All the best qualities of wood (an environmentally friendly material which has been in harmony with man for centuries) captured in CAL doors will give you the confidence that a glamorous wood door is useful and will give added dimension to your home.

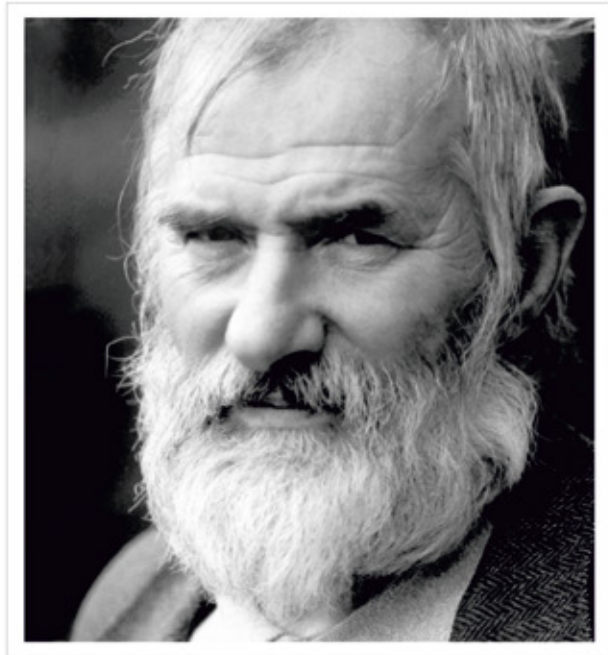

For over 30 years, we have been improving our products for you. Over one hundred of our professionals supervise the entire manufacturing process to ensure that you receive your door, which not only meets the desire of a safe, cosy and peaceful home, but also works with the owner.

Bearing in mind that a door can be a showcase of a house for many years, we have prepared a wide selection of designs for lovers of both classic and modern finishing, with steel, glass, quartz sinters or aluminium details. Our innovative solutions allow us to give you the opportunity to build custom door openings, and thus to create unique works of art from our already exceptional doors.

Every CAL door that you choose is of the same consistent quality and meets the highest production standards. I can guarantee that you will receive the product from the most innovative manufacturer in the industry; we define trends in innovation and technology. Our products are being recommended by owners of door woodwork distribution networks, as recommended by independent notified bodies. You can find them in the Papal Apartments in the Wigry Monastery, Poland, the Polish Embassy in Riga, Latvia and in many other places all around Europe and the world.

After all these years, wooden doors are still an exciting subject for us and we are constantly open to exploring the exciting new technologies of their construction, because for as long as we can remember development meant exploring new opportunities. Our inspiration comes from nature.

When you choose a CAL door, you can be sure that they will be an excellent product, that will be a source of pride and joy for many years, and that returning home will always be a pleasure.

Select the quality in every CAL-way.

Zbigniew Cywiński

CEO CAL

I. Selected projects	
III. About us:	
1. Why CAL? .....	6
2. Love Story .....	7
III. Choose your doors:	
1. AluTherm collection .....	8
2. Knight collection .....	12
3. Movie Stars collection .....	18
4. Arctic collection .....	22
5. Luxury collection .....	26
6. Classic collection .....	30
7. Stone collection .....	34
IV. Technology	
1. Exterior door overview .....	38
2. Colours and coating system .....	39
3. Custom design products .....	40
4. Sidelights and transom system .....	42
5. Made to measure doors .....	43
6. Installation guidelines with TOP® .....	44
V. Smart doors	46
VI. Interior doors line	48
VII. Features and specifications	50
1. Price comparison sheet .....	52
2. Certificates .....	53
VIII. Accessories	54

## Why is it worth choosing CAL ?

Only a carefully chosen front door can emphasize the beauty and charm of your new home. This is the essence of the entire design process and it's worth resisting the temptation of cost savings and to make sure that your home becomes safe and warm - and in one word - perfection.

Low quality, poorly performing doors without anti-burglar certificates simply cannot ensure the necessary characteristics of an Entry door.

And are simply unattractive

**REMEMBER!** The door will be the showcase of your house for many years. A wood door is not just an expense - it is an investment in your comfort and safety.

**30** years on the market

Key employees have been working in the company for over 15 years, and the most experienced ones even longer. By respecting them - we respect you.



More than 100,000 manufactured doors

Each manufactured door is inspiring us to create innovative solutions and to increase the market value of your house.



Over 130 Authorized Mounting Groups

We guarantee that your door will be installed by the true professionals.

## WHAT WILL YOU GAIN BY BUYING A CAL DOOR?



**Real savings on heating that you will feel in your wallet.** Thermal insulation even at the level of 0.58 W / m<sup>2</sup>K in conjunction with the patented Thermal Threshold Beam (Top ©) effectively eliminates heat loss.



**Peaceful holidays.** As a standard - high class resistance to burglary (RC2). All our doors are equipped with a burglary-proof rebate, Winkhaus multipoint lock and Low-E security glass. It's our norm which becomes a standard for other Polish door producers.



The product of the highest quality with the best after-sales service. Steel strengthening, 4 coats of paint, 4 hinges adjustable on 3 planes, and this is only the beginning. We will support you with a professional service, and if necessary also with the "Door Clinic".



**Airtight vestibule** - double or triple system of seals around the frame, meeting precisely defined functions, prevents uncontrolled air exchange.



**Quiet House** - Inside your house you will only hear what you desire to hear. The sound insulation R<sub>w</sub> - even up to 42 dB.



Your children will be breathing in a healthy world. We use environmentally friendly materials, such as wood derived exclusively from forests managed according to the FSC standards.



**The house that cooperates with the owner,** For example you can be notified when your children come home, but the technology does not control you.



**Emphasizing the individuality of your home** - an "individually tailored" door that will be admired by your neighbours. We offer a wide range of designs for classic and modern finishing fans.



The whole manufacturing process is being conducted in the European Union with the participation of Polish well-qualified staff.

# A STORY ABOUT THE PASSION FOR WOOD AND FULFILLED DREAMS

We started over 30 years ago as a team composed of only 10 people. The beginnings were not easy - we had huge problems with the supply of both materials and machinery. The plant where we started was only 300m<sup>2</sup> in size after two years, we built another 350 m<sup>2</sup>. In 1989, we merged two companies: Joinery Workplace Cywiński and Antonik with the Company ZSB Lutostański - to create a new company called CAL (derived from the initials of the founders). Then we purchased a plot of land where the company is located today. We had three work areas 600 m<sup>2</sup> available.

Today, CAL is a fast growing Company with a management system based on lean management principles and drawing from the Theory of Constraints. Currently, the company employs more than 100 people and is a leader in the production of exterior doors. It is constantly improving its products and introduces innovative solutions, such as the Burglary-Proof Rebate, Thermal Threshold Beam (Top ®) and remote control, which has become the industry standard. To provide the ultimate care for our product and to make sure that the door will always be installed by professionals who have the proper knowledge and experience we introduced the Authorization of Mounting Groups (AMG). The total area of our production facility is currently 2,800 m<sup>2</sup>. Branded Products by CAL are available not only in Poland but also on foreign markets: in England, Germany, Austria, Ireland, Lithuania, Estonia, Scandinavia and Canada.

Our top priority is to provide an honest approach to the customer. As an experienced family company, which bears the name of its founder, we feel obliged to comply with the universal values, which are not subject to fashion or trends in marketing. Therefore we tell the truth about our products - their reliability is confirmed by numerous certificates issued by independent institutions. Our success guarantees stability and confidence that the company will survive every crisis. We rely on such proven, reputable suppliers as Winkhaus, VBH, Teknos and 3M. CAL is our life. We love wood, and our passion enables us to fulfill our customers' dreams - the dreams of a beautiful home.



# ALUTHERM COLLECTION

Our Premium Class of wood door with exterior aluminum cladding - we offer beautiful interior wood and space age materials throughout. The model names are inspired by the book "Fables for Robots" by Stanislaw Lem, the famous Polish science fiction writer.

With over one hundred different colours of aluminum claddings available, these doors will give you a perfect architectural fit for your construction project that uses the same style of windows. The best exterior protection will provide years of maintenance free use, while the warm tones of interior wood will highlight any design. Based on the Arctic construction model, these doors offer exceptional thermal characteristics. U-value of 0.58 w/m<sup>2</sup>K in the 94mm door thickness, will make this a perfect choice for any high energy efficiency project.

This collection allows you to use all the advantages of wood's thermal properties and natural beauty, combined with robust aluminum exterior. The Alutherm Door Collection will appeal to people looking for a modern design, and maintenance free use.



Standard Thermo RC2  
option: Standard Arctic RC2

**Sound insulation**  
R<sub>w</sub>= 34dB

Effectively protect against noise from the outside

**Security**  
RC2 class

Standard that will be introduced in the near future in most EU countries

**Heat transfer coefficient**  
U<sub>d</sub>= 0,9 W/m<sup>2</sup>K

Doors meet the highest standards for energy-efficient homes





DECYURAN  
Alu 01













DEKASUW  
Alu 02



FERMTOFERM  
Alu 03



GIGABALL  
Alu 04

-   
**Sound insulation**  
Rw=34dB
-   
**4 hinges**
-   
**Double rebated**  
82mm thick
-   
**Burglar resistance**  
class RC2
-   
**Energy efficiency**
-   
**Heat transfer coefficient**  
Ud= 0,9 W/m²K
-   
**Carefully selected wood**
-   
**100%**
-   
**High quality**
-   
**Almost all colours of the world**



# ALUTHERM COLLECTION

*This door series can also be built to the Arctic door standard*



MEGACAL  
Alu 05

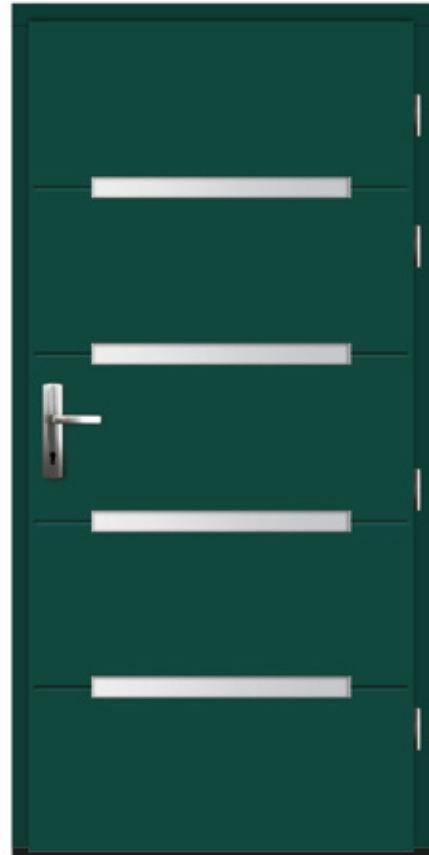

MEGAHEL  
Alu 06



MILITOR  
Alu 07



NANOAKTYN  
Alu 08

  
Sound insulation  
Rw=34dB

  
4 hinges

  
Double rebated  
82mm thick

  
Burglar resistance  
class RC2

  
Energy efficiency

  
Heat transfer coefficient  
Ud= 0,9 W/m²K

  
Carefully selected wood

  
100%

  
High quality

  
Almost all colours  
of the world



NANOTECH  
 Alu 09

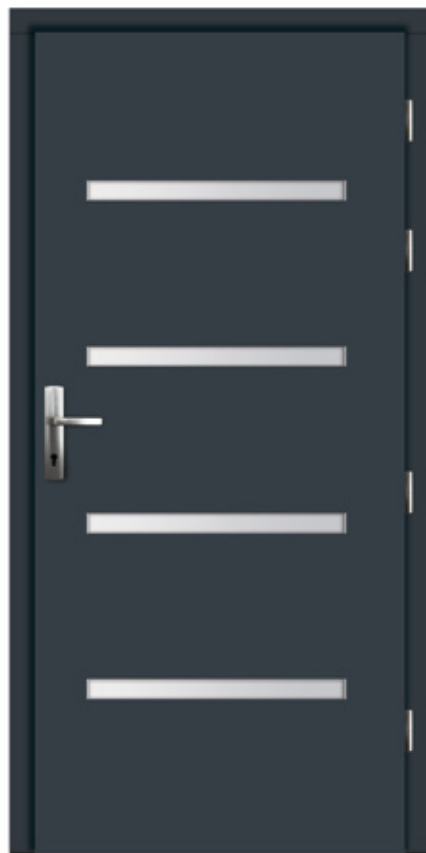











OKTARYN  
 Alu 10



ZEPTORAD  
 Alu 11



ZETTAREN  
 Alu 12

-   
 Sound insulation  
 Rw=34dB
-   
 4 hinges
-   
 Double rebated  
 82mm thick
-   
 Burglar resistance  
 class RC2
-   
 Energy  
 efficiency
-   
 Heat transfer  
 coefficient  
 Ud= 0,9 W/m²K
-   
 Carefully  
 selected wood
-   
 100%
-   
 High quality
-   
 Almost all colours  
 of the world

# KNIGHT COLLECTION

On the 600th anniversary of the Battle of Grunwald we introduced a collection inspired by the achievements of Polish knights. Each model bears the name of a proud hero of many battles. "The door shod in steel" like a knight in armour remains fashionable. The combination of cold metal and warm wood match to any modern home, while fulfilling the requirements of minimalist arrangements, e.g. made from raw concrete.

Decorative elements of high-quality stainless steel supplemented by properly selected hardware such as the Stainless Steel colour handle designed by AXA specifically for CAL, are perfectly in tune with contemporary construction trends. The door of the Knight collection is an emanation of the modern design.



Standard Thermo RC2

**Sound insulation**  
 $R_w = 34 \text{ dB}$

Effectively protect against noise from the outside

**Security**  
RC2 class

Standard that will be introduced in the near future in most EU countries

**Heat transfer coefficient**  
 $U_d = 0,9 \text{ W/m}^2\text{K}$

Doors meet the highest standards for energy-efficient homes



FARUREJ  
 Ryc 01













FLORIAN  
 Ryc 02



HIŃCZA  
 Ryc 03



JAGIENKA  
 Ryc 04

-   
 Sound insulation  
 Rw=34dB
-   
 4 hinges
-   
 Double rebated  
 78mm thick
-   
 Burglar resistance  
 class RC2
-   
 Energy efficiency
-   
 Heat transfer  
 coefficient  
 Ud= 0,9 W/m²K
-   
 Carefully  
 selected wood
-   
 100%
-   
 High quality
-   
 Almost all colours  
 of the world



# KNIGHT COLLECTION



JAKSA  
Ryc 05



JURAND  
Ryc 06



LONGINUS  
Ryc 07



MSZCZUJ 4s  
Ryc 08



Sound insulation  
Rw=34dB



4 hinges



Double rebated  
78mm thick



Burglar resistance  
class RC2



Energy  
efficiency



Heat transfer  
coefficient  
Ud= 0,9 W/m²K



Carefully  
selected wood



100%



High quality



Almost all colours  
of the world



**MSZOCZUJ**  
 Ryc 09













**SĘDZIWÓJ**  
 Ryc 10



**SKARBEK**  
 Ryc 11



**SŁAWIEC**  
 Ryc 12

-   
**Sound insulation**  
Rw=34dB
-   
**4 hinges**
-   
**Double rebated**  
78mm thick
-   
**Burglar resistance**  
class RC2
-   
**Energy efficiency**
-   
**Heat transfer coefficient**  
Ud= 0,9 W/m²K
-   
**Carefully selected wood**
-   
**100%**
-   
**High quality**
-   
**Almost all colours**  
of the world



# KNIGHT COLLECTION



ZAWISZA  
Ryc 13

! Knotty oak veneer available upon request













ZBIGNIEW  
Ryc 14



ZELWA  
Ryc 15



ZYNDRAM  
Ryc 16

-  Sound insulation  $R_w=34dB$
-  4 hinges
-  Double rebated 78mm thick
-  Burglar resistance class RC2
-  Energy efficiency
-  Heat transfer coefficient  $U_d=0,9 W/m^2K$
-  Carefully selected wood
-  100%
-  High quality
-  Almost all colours of the world





DŁUGIE  
 Ryc 17













GARBAŚ  
 Ryc 18



OKRĄGLE  
 Ryc 19



SUMOWO  
 Ryc 20

-   
**Sound insulation**  
Rw=34dB
-   
**4 hinges**
-   
**Double rebated**  
78mm thick
-   
**Burglar resistance**  
class RC2
-   
**Energy efficiency**
-   
**Heat transfer coefficient**  
Ud= 0,9 W/m²K
-   
**Carefully selected wood**
-   
**100%**
-   
**High quality**
-   
**Almost all colours of the world**

# MOVIE STARS COLLECTION

Who can remember the Silver Screen stars whose names have been used for our Movie Stars collection? This collection - impressive and diverse - is as beautiful as those stars. Their modern design is based on various glass forms (painted ceramic or Venetian mirror) combined with organic material to warm the captivating coolness of a smooth sheet of ice by the natural drawing of wood.

Those doors are for the customers who appreciate the latest and minimalist trends combined with fondness of healthy materials that have been for centuries in harmony with humans. This perfect marriage of femininity and masculinity, the beauty and appearance of freshness is linked with perfect usefulness. The products fulfill high quality standards in terms of implementation and technical parameters. Doors from the Movie Stars collection will play an important function in any project and your home will win a unique glow.



Standard Thermo RC2

**Sound insulation**  
 $R_w = 34 \text{ dB}$

Effectively protect against noise from the outside

**Security**  
RC2 class

Standard that will be introduced in the near future in most EU countries

**Heat transfer coefficient**  
 $U_d = 0,9 \text{ W/m}^2\text{K}$

Doors meet the highest standards for energy-efficient homes



AUDREY  
 Film 01

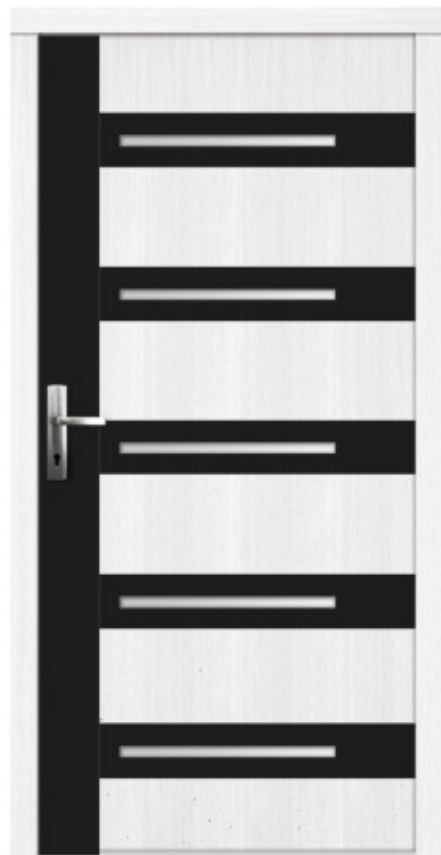











BRIGITTE  
 Film 02



CLAUDIA  
 Film 03



ELIZABETH  
 Film 04

-   
 Sound insulation  
 Rw=34dB
-   
 4 hinges
-   
 Double rebated  
 78mm thick
-   
 Burglar resistance  
 class RC2
-   
 Energy efficiency
-   
 Heat transfer  
 coefficient  
 Ud= 0,9 W/m²K
-   
 Carefully  
 selected wood
-   
 100%
-   
 High quality
-   
 Almost all colours  
 of the world



# MOVIE STARS COLLECTION



**GRACE**  
Film 05

! Knotty oak veneer available upon request



**GRETA**  
Film 06

! Knotty oak veneer available upon request













**INGRID**  
Film 07

! Knotty oak veneer available upon request



**KATHERINE**  
Film 08

! Knotty oak veneer available upon request

-  Sound insulation  $R_w=34dB$
-  4 hinges
-  Double rebated 78mm thick
-  Burglar resistance class RC2
-  Energy efficiency
-  Heat transfer coefficient  $U_d= 0,9 W/m^2K$
-  Carefully selected wood
-  100%
-  High quality
-  Almost all colours of the world



**MARLENE**  
 Film 09

! Knotty oak veneer available upon request



**MARILYN**  
 Film 10

! Knotty oak veneer available upon request













**ROMY**  
 Film 11

! Knotty oak veneer available upon request



**SOPHIA**  
 Film 12

! Knotty oak veneer available upon request

-   
**Sound insulation**  
Rw=34dB
-   
**4 hinges**
-   
**Double rebated**  
78mm thick
-   
**Burglar resistance**  
class RC2
-   
**Energy efficiency**
-   
**Heat transfer coefficient**  
Ud= 0,9 W/m²K
-   
**Carefully selected wood**
-   
**100%**
-   
**High quality**
-   
**Almost all colours of the world**

# ARCTIC COLLECTION

This is our flagship collection! It is dedicated to clients who are aiming for Passive House or high levels of energy efficiency. Each door bears the name of an Arctic region of the world, where these doors would surely be suitable. Our goal is to keep the cold OUT and the warm IN!

The Arctic collection is a significant upgrade from a Classic door. The construction of this line of doors is very different from our other models and allows us to offer improved technical characteristics and accessories.

Our many years of experience in the production of external doors and in cooperation with testing laboratories, we have developed an impressive line of energy efficient Entry doors suitable for the most demanding cold climates. This line of doors can meet the demanding requirements for Passive House construction and other energy efficiency projects. Our most efficient door has a thermal U-value rating of an amazing 0.58 W/m<sup>2</sup>K. The entire line offers complete airtightness on all four sides, a feature not offered by all manufacturers. The airtight closure is guaranteed by the standard auto-lock multipoint locking system that pulls the door slab into the frame when the door is closed.

Standard RC2-class anti-burglary locks provide a safe and secure environment for your family.

The Arctic line has been designed for clients who are energy conscious and who appreciate the sleek lines of the wood profiles of an entry door. The Arctic line will also help ensure that your warm environment stays on the inside of your home.



Standard Arctic RC2

**Sound insulation**  
R<sub>w</sub>= 34dB

Effectively protect against noise from the outside

**Security**  
RC2 class

Standard that will be introduced in the near future in most EU countries

**Heat transfer coefficient**  
U<sub>d</sub> 0,58 W/m<sup>2</sup>K

Doors meet the highest standards for energy-efficient homes



CZUKOTKA  
Arkt 01













JUKON  
Arkt 02



KAMCZATKA  
Arkt 03



LABRADOR  
Arkt 04

-   
 Sound insulation  
 $R_w=34dB$
-   
 4 hinges
-   
 Double rebated  
 90mm thick
-   
 Burglar resistance  
 class RC2
-   
 Energy efficiency
-   
 Heat transfer  
 coefficient  
 $U_d= 0,58 W/m^2K$
-   
 Carefully  
 selected wood
-   
 100%
-   
 High quality
-   
 Almost all colours  
 of the world



# ARCTIC COLLECTION



LAPONIA  
Arkt 05



NUUK  
Arkt 06



PORSANGER  
Arkt 07



ROVANIEMI  
Arkt 08

  
Sound insulation  
Rw=34dB

  
4 hinges

  
Double rebated  
90mm thick

  
Burglar resistance  
class RC2

  
Energy  
efficiency

  
Heat transfer  
coefficient  
Ud= 0,58 W/m²K

  
Carefully  
selected wood

  
100%

  
High quality

  
Almost all colours  
of the world





SPITSBERGEN  
Arkt 09













SVALBARD  
Arkt 10



THULE  
Arkt 11



WRANGLER  
Arkt 12

-   
**Sound insulation**  
Rw=34dB
-   
**4 hinges**
-   
**Double rebated**  
90mm thick
-   
**Burglar resistance**  
class RC2
-   
**Energy efficiency**
-   
**Heat transfer coefficient**  
Ud= 0,58 W/m²K
-   
**Carefully selected wood**
-   
**100%**
-   
**High quality**
-   
**Almost all colours of the world**

# LUXURY COLLECTION

The names of this collection have been inspired by the 8000m peaks of the Himalayas - because higher quality doesn't exist.

The Luxury collection is characterised by: noble and especially selected oak, perfect handmade finishing, unique construction, passive house suitable and high-quality fittings. This collection is designated for the experts who recognize the natural beauty and appreciate each individual piece of a house. Eight basic models are often used as the starting point for the creation of unique portals with side and upper panels and stained glass. This is the perfect link between sophisticated appearance and great utility.

The Luxury collection will enhance your home based on timeless beauty and aristocratic elegance.



Standard Thermo RC2

**Sound insulation**  
 $R_w = 34 \text{ dB}$

Effectively protect against noise from the outside

**Security**  
RC2 class

Standard that will be introduced in the near future in most EU countries

**Heat transfer coefficient**  
 $U_d = 0,9 \text{ W/m}^2\text{K}$

Doors meet the highest standards for energy-efficient homes



ANNAPURNA  
 Luks 01













CZOGORI  
 Luks 02



CZOMOLUNGMA  
 Luks 03



DHAULAGIRI  
 Luks 04

-   
**Sound insulation**  
Rw=34dB
-   
**4 hinges**
-   
**Double rebated**  
90mm thick
-   
**Burglar resistance**  
class RC2
-   
**Energy efficiency**
-   
**Heat transfer coefficient**  
Ud= 0,9 W/m²K
-   
**Carefully selected wood**
-   
**100%**
-   
**High quality**
-   
**Almost all colours of the world**



# LUXURY COLLECTION



LHOTSE  
Luks 05



MAKALU  
Luks 06



MANASLU  
Luks 07



NANGA PARBAT  
Luks 08

  
Sound insulation  
Rw=34dB

  
4 hinges

  
Double rebated  
90mm thick

  
Burglar resistance  
class RC2

  
Energy  
efficiency

  
Heat transfer  
coefficient  
Ud= 0,9 W/m²K

  
Carefully  
selected wood

  
100%

  
High quality

  
Almost all colours  
of the world



# OVER 200 000 OPENINGS AND CLOSINGS.

THAT'S OVER 20 YEARS OF USE!

That is how long our doors will provide trouble free service. All you need to do from time to time is gentle wipe them down.

That's what we call maintenance-free. We checked it out at the Institute for Building Technology!

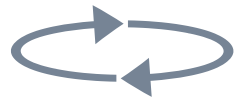

**200 000 openings  
and closings**



# CLASSIC COLLECTION

The Classic collection's designs are modest and timelessly beautiful like the Polish mountains. The collection models have been named after those geographic regions.

Their classic designs have stood the test of time for many years and remain popular in the market. Those models with their traditional appearance combined with modern construction will be a timeless addition to any house built with love. Doors from the Classic collection will be the perfect finishing touch of your home.

The house will welcome guests with conventional beauty and you will be living in a comfortable house providing warm atmosphere.



Standard Comfort RC2

**Sound insulation**  
 $R_w=30-31dB$

Effectively protect against noise from the outside

**Security**  
RC2 class

Standard that will be introduced in the near future in most EU countries

**Heat transfer coefficient**  
 $U_d=1,3 W/m^2K$

Doors meet the highest standards for energy-efficient homes



CZANTORIA  
 Klas 01













JAWORNIK  
 Klas 02



KORUNA  
 Klas 03



MALINÓW  
 Klas 04

-   
 Sound insulation  
 $R_w=30-31$  dB
-   
 4 hinges
-   
 Double rebated  
 65mm thick
-   
 Burglar resistance  
 class RC2
-   
 Energy efficiency
-   
 Heat transfer coefficient  
 $U_d= 1,3$  W/m<sup>2</sup>K
-   
 Carefully selected wood
-   
 100%
-   
 High quality
-   
 Almost all colours  
 of the world



# CLASSIC COLLECTION



SKALNIAK  
Klas 05













SKRZYCZNE  
Klas 06



SOKÓŁ  
Klas 07



SZCZELINIEC  
Klas 08

-  Sound insulation  
Rw=30-31dB
-  4 hinges
-  Double rebated  
65mm thick
-  Burglar resistance  
class RC2
-  Energy efficiency
-  Heat transfer coefficient  
Ud= 1,3 W/m²K
-  Carefully selected wood
-  100%
-  High quality
-  Almost all colours  
of the world





SZCZYTNA  
 Klas 09













ŚNIEŻKA  
 Klas 10



ŚNIEŻNIK  
 Klas 11



ŻMIJOWIEC  
 Klas 12

-   
 Sound insulation  
 $R_w=30-31$  dB
-   
 4 hinges
-   
 Double rebated  
 65mm thick
-   
 Burglar resistance  
 class RC2
-   
 Energy  
 efficiency
-   
 Heat transfer  
 coefficient  
 $U_d= 1,3$  W/m<sup>2</sup>K
-   
 Carefully  
 selected wood
-   
 100%
-   
 High quality
-   
 Almost all colours  
 of the world

# STONE COLLECTION

Doors from the Stone collection are finished with inserts of sintered quartz. The Stone collection draws its names from European "places of power", such as mysterious forests or megalith and menhirs.

These doors are a perfect combination of such completely different organic raw materials like stone and wood, enclosed in exceptional functional forms. These doors not only allow you to create a unique style, but also ensure increased resistance to different weather conditions. Moreover, this collection is also created for animal lovers, because the stone inserts in the door are resistant to scratching by our impatient four-legged friends.

Doors from the Stone collection are CAL's answer to the popular "return to the nature" trend while they maintain an ultra-modern appearance.

Optionally, a safe stone inner cladding can be added, in order to protect the door leaf against our four-legged friends.



Standard Thermo RC2  
option: Standard Arctic RC2

**Sound insulation**  
 $R_w = 34 \text{ dB}$

Effectively protect against noise from the outside

**Security**  
RC2 class

Standard that will be introduced in the near future in most EU countries

**Heat transfer coefficient**  
 $U_d = 0,9 \text{ W/m}^2\text{K}$

Doors meet the highest standards for energy-efficient homes



**GEREON**  
Kam 01













**GLASTONBURY**  
Kam 02



**JAROWIT**  
Kam 03



**KAILAS**  
Kam 04

-   
**Sound insulation**  
Rw=34dB
-   
**4 hinges**
-   
**Double rebated**  
78mm thick
-   
**Burglar resistance**  
class RC2
-   
**Energy efficiency**
-   
**Heat transfer coefficient**  
Ud= 0,9 W/m²K
-   
**Carefully selected wood**
-   
**100%**
-   
**High quality**
-   
**Almost all colours of the world**



# STONE COLLECTION

*This door series can also be built to the Arctic door standard*



MNAJDRA  
Kam 05





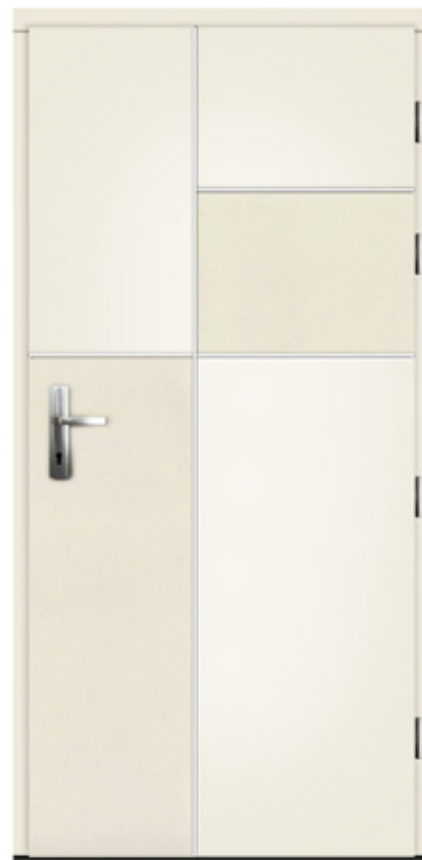







PERUN  
Kam 06



PETRA  
Kam 07



TITICACA  
Kam 08

-   
Sound insulation  
Rw=34dB
-   
4 hinges
-   
Double rebated  
78mm thick
-   
Burglar resistance  
class RC2
-   
Energy  
efficiency
-   
Heat transfer  
coefficient  
Ud= 0,9 W/m²K
-   
Carefully  
selected wood
-   
100%
-   
High quality
-   
Almost all colours  
of the world



TARXIEN  
Kam 09



WELES  
Kam 10













YONAGUNI  
Kam 11

! Knotty oak veneer available upon request



ZORZA  
Kam 12

-   
**Sound insulation**  
Rw=34dB
-   
**4 hinges**
-   
**Double rebated**  
78mm thick
-   
**Burglar resistance**  
class RC2
-   
**Energy efficiency**
-   
**Heat transfer coefficient**  
Ud= 0,9 W/m²K
-   
**Carefully selected wood**
-   
**100%**
-   
**High quality**
-   
**Almost all colours of the world**

# CAL EXTERIOR DOOR OVERVIEW

## standards and options



Standard colour range matches the most popular finishes used for facades, windows and garage doors. Strong and built to last.

Standard: five door leaf thicknesses available: 65, 78, 82, 90 and 94mm. Made of glue laminated timber.



Custom sizes and shapes available. This solution ensures an efficient thermal insulation.

Standard: 65mm-thick (optionally 88mm) glue laminated timber frame



Silence.  
Energy efficiency  
Comfort.

Standard: two or three weatherstrips in each door



Security.  
Convenience - doors cooperating with the owner.

Standard: RC2 class. German anti-burglar three-point lock.  
Option: RC3 class, electric or automatic lock, smart home devices, four or five-point lock



Warmth - elimination of thermal bridges under the door.  
Convenience - low threshold.

Standard: thermally broken low aluminium threshold with an additional 80mm Thermal Threshold Beam



UNIQUE DOORS FOR A UNIQUE HOME  
- Always with the CAL logo.

Door closer - Quiet closing  
Shuts tight every time.  
Lock open option available.

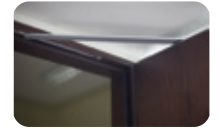

Option: door closer concealed within the leaf.

Security: CAL's innovation that has become a standard - not only in Poland - in production of wooden doors.



Standard: Anti-burglar "French rebate"

Fine adjustment of the door.  
Smooth operation.  
Warp resistance.

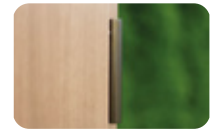

Standard: Four hinges adjustable in three directions

Modern designs.  
Large glass panels.  
Security.  
Warmth. Comfort.



Standard: Low-E security glass, triple glazing.

Aesthetic and durable door furniture.  
Accessories come from the finest suppliers.



Standard: wide range of door accessories like handles, pull bars, hinge covers, door knobs etc. all in uniform colours.

## COLOURS



## THE CAL DOOR COATING SYSTEM

The entire CAL coating system is based on waterborne, ecological products that ensure an attractive and natural look, that will last for many years, despite the impact of external weather conditions. Before choosing a door it's worth asking whether it has been painted with solvent-based paints. All products in the Teknos coating systems used by CAL meet applicable EU standards for the protection of exterior wood. They also comply with the reach requirements, and with the EU VOC regulations

### HIGHEST LEVEL OF TRANSPARENCY

Many years of experience gained through intensive research and testing have allowed us to create a transparent system of coatings for external use, completely free from the effects of turbidity and highlighting the undeniable aesthetic qualities of natural wood in an elegant way.

### EFFECTIVE UV RADIATION PROTECTION

Lightfast pigments in combination with highly efficient UV absorbers are an effective barrier against sunlight and effectively protect the lignin inside the wood against decay.

### EFFECTIVE IMPREGNATION FOR WOOD PROTECTION

Water-borne wood preservative is a unique combination of two fungicides, providing full protection against all types of biological corrosion, and resins with a high degree of emulsification provide deep penetration of impregnation into the wood.



This preservative method, includes active substances which are penetrate deep inside the wood.

Impregnate evaporates but the active particles stay inside the wood in order to protect the wood against biological corrosion.



The traditional system of acrylic coating (picture on the left). The Teknos Coating system, on the right.

Optimal protection and adhesion are achieved due to deep particles penetration inside the wood structure.

ALUTHERM RAL STANDARD - Dual colour RAL+RAL with extra payment

RAL 9016, RAL 9007, RAL 9006, RAL 9005, RAL 8019, RAL 8017, RAL 8011, RAL 8007, RAL 8003, RAL 8001, RAL 7042, RAL 7035, RAL 7001, RAL 6029, RAL 6005, RAL 5015, RAL 5013, RAL 5010, RAL 3003, RAL 3002, RAL 1013, RAL 1033, RAL 7016.

### HIGH RESISTANCE TO WATER AND VAPOUR PERMEABILITY

Teknos coating systems ensure the achievement of rapid resistance to rainwater and effectively eliminate the problem of water penetrating under the coating.

### HARDNESS HAND IN HAND WITH ENHANCED FLEXIBILITY

After drying, Teknos protective coatings create a smooth and suitably tough, but also flexible finishing layer. It is a kind of protective shield that is resistant to cracking caused by changes in wood humidity and temperature.

### PEOPLE AND ENVIRONMENT FRIENDLY

Teknos Industrial Coatings are available in a wide range of transparent colors and in an almost unlimited number of opaque colors. Our products are environmentally friendly, and joinery user friendly.

### EXCELLENT SUBSTRATE ADHESION

By using a unique technology, we managed to reduce the size of pigment particles and binders to less than 0.1 micron. Thus, the achieved effect of deeper penetration and anchoring in the substrate takes the quality of protective coatings of Teknos to a whole new level

# CUSTOM DESIGN PRODUCTS

ALL CAL DOORS CAN BE DESIGNED AND MANUFACTURED TO OUR CLIENT'S DESIGN SPECIFICATIONS AND DIMENSIONS, OFFERING A WIDE RANGE OF STYLES FOR ALL PROJECT TYPES. AS WELL AS STANDARD DOOR DESIGNS, CAL USES ADVANCED TECHNOLOGY WHICH ALLOWS COMPLEX DESIGNS TO BE EASILY TRANSLATED INTO THE MANUFACTURING PROCESS. DOORS CAN BE CREATED TO A CLIENT'S SPECIFIC DESIGN AND CAN ALSO BE EQUIPPED WITH NON-STANDARD DOOR HARDWARE, AND FINISHED IN ANY RAL COLOUR TO MATCH THE STYLE OF YOUR HOME. IF YOU HAVE A SPECIAL DESIGN AS PART OF YOUR PROJECT AND YOU NEED ASSISTANCE, WE ARE HERE TO HELP. PLEASE CONTACT YOUR LOCAL CAL DEALER OR US DIRECTLY - [wyceny@drzwi-cal.pl](mailto:wyceny@drzwi-cal.pl)

DOUBLE DOOR  
asymmetrical  
Lhotse

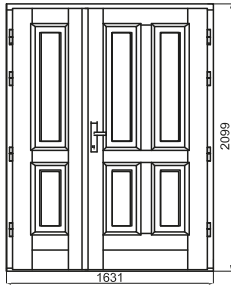

SINGLE DOOR  
with 1 dummy sash sidelight  
Makalu

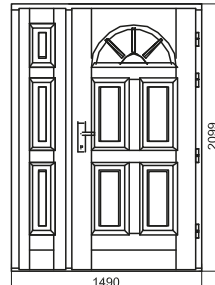

SINGLE DOOR  
with 2 dummy sash sidelights  
Annapurna

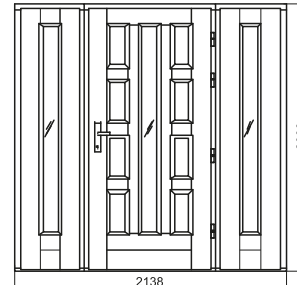

SINGLE DOOR  
with 1 sidelight  
Brigitte

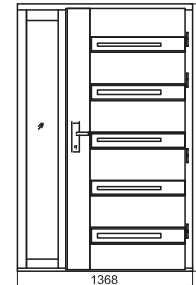

SINGLE DOOR  
with 2 sidelights  
Grace

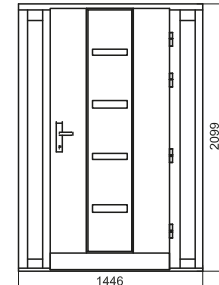

Czantoria

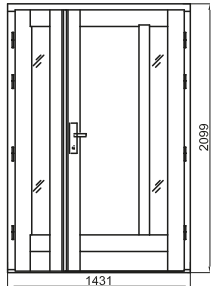

Okągłe

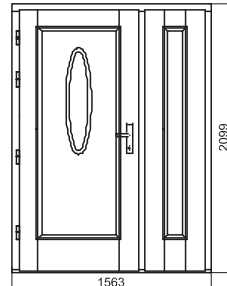

Thule

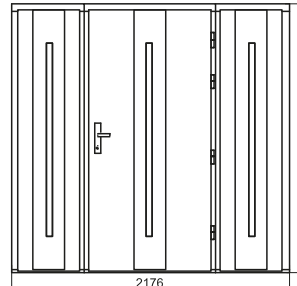

Jawornik

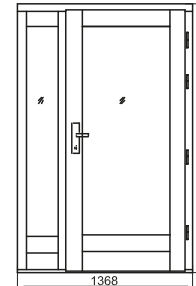

Zbigniew

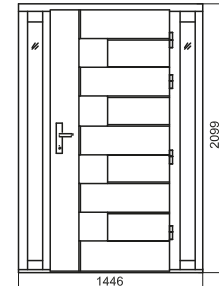

Florian

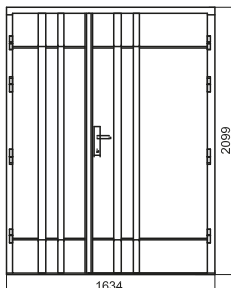

Zawisza

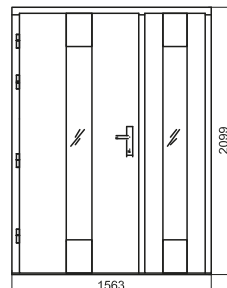

Mszczuj

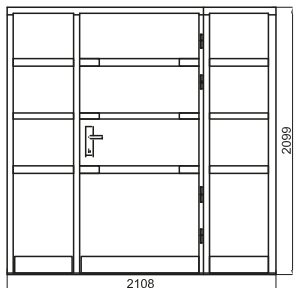

Longinus

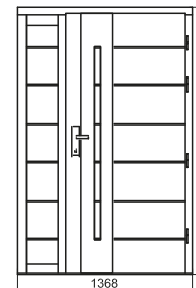

Szczytna

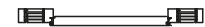
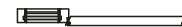
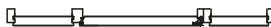
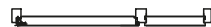
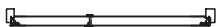
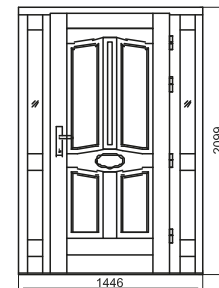



# SPECIAL DESIGNS ARE OUR SPECIALTY

HERE ARE SOME EXAMPLES OF DOORS WE HAVE BUILT. PLEASE ALSO CONSULT OUR PORTFOLIO PAGE FOR SOME DESIGN IDEAS - [www.drzwi-cal.pl/drzwi-zewnetrzne-zdjecia-produktowe/](http://www.drzwi-cal.pl/drzwi-zewnetrzne-zdjecia-produktowe/)

CUSTOM DOOR

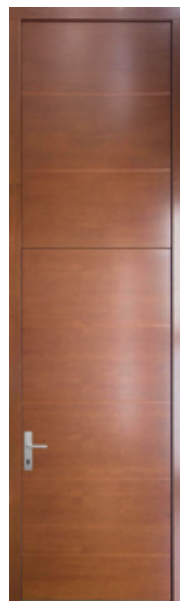

ŚLEZA



LHOTSE



CUSTOM DOOR



GRACE



CUSTOM DOOR



CUSTOM DOOR



MSZCZUJ

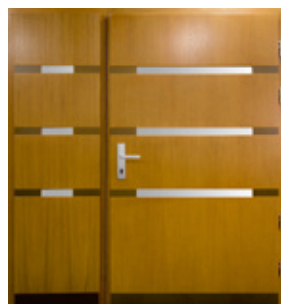

LONGINUS



NUUK



ŚNIEŻKA



MEGACAL



LONGINUS



ŚLEZA



CUSTOM DOOR



ANNAPURNA

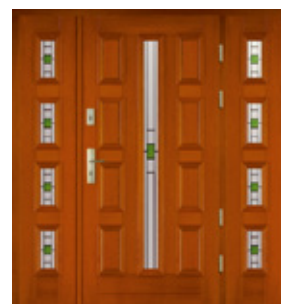

CZOGORI



CUSTOM DOOR



LONGINUS

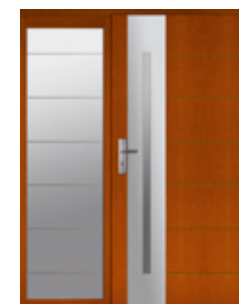

CUSTOM DOOR



# SIDELIGHTS & TRANSOM SYSTEM



HEAT

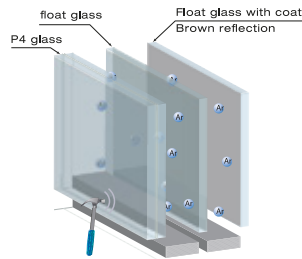

Always triple glazed!  
Two argon filled cavities for a 68 mm glazing unit and U-value of 0.6 W/m²K!



SECURITY

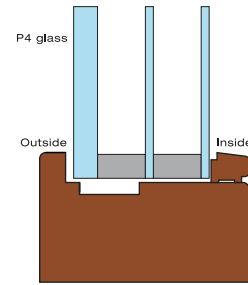

Always glazed from the inside.  
P4 glass is always outside.  
P4 Glass - a laminated glass - is the equivalent in strength to a 150mm x 150mm grid of 10mm steel bars



EASY INSTALLATION



Assembly on site is easy!  
All materials (screws and foam tape) are supplied



GREAT DIMENSIONS

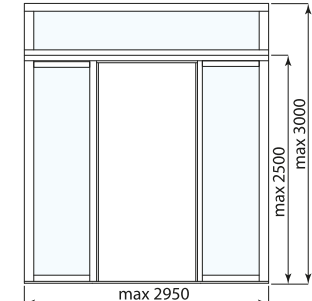

Doors of 2500mm in height, plus transom and sidelights can make big doors indeed!

## SIDELIGHTS & TRANSOM



SD with transom

SDS with transom

DS with transom

VIEWED FROM THE EXTERIOR. THE FOLLOWING COMBINATIONS ARE POSSIBLE:

SD - Sidelight + Door

SDS - Double Sidelight + Door

DS - Door + Sidelight

### TRANSOM

Common solution for traditional and modern sidelights



### SIDELIGHT TYPES

TRADITIONAL SIDELIGHTS  
(fit the best with panel doors)



Model T1 Model T2 Model T3 Model T4

MODERN SIDELIGHTS  
(fit the best with flush doors)



Model N1 Model N2 Model N3 Model N4

# MADE TO MEASURE DOORS

Easy way to modify our standard sizes to fit existing wall opening or to suit your needs. A large number of CAL doors can be made to your size.

Normally, they are at the high end of our price structure for exterior custom doors but each and every part is a solid piece of timber without any exception, quality is the start and end when making any custom door.

### FRAME WIDENING

available as standard 50 or 65 mm, surcharge for jambs 70, 80 or 88mm thick, standard frame inner dimensions remain unchanged.

DOOR SIZE			
S	M	L	XL
SF	CHG	CHG	CHG

SF - size without surcharge  
CHG - size with surcharge

### TALLER/SHORTER DOOR

allows to change the height of the door remaining the standard width. We recommend frame widening for doors more than 2200mm in height.

DOOR SIZE			
S	M	L	XL
CHG	CHG	CHG	CHG

CHG - size with surcharge  
It does not refer to Movie Star collection - individual pricing.

### TALLER/SHORTER/WIDER DOOR

allows to change both height and width of the door. We recommend frame widening for doors more than 2200 mm in height.

DOOR SIZE		
MTM HEIGHT	MTM WIDTH	MTM HEIGHT & WIDTH
CHG	CHG	CHG

CHG - size with surcharge  
Making door to required size, must be confirmed by CAL

\* refers to following collections: Arctic, Luxury and Stone or Alutherm if made in Standard Arctic  
\*\* frame inner width 90 cm

# INSTALLATION GUIDELINES WITH TOP®

Welcome to TOP! TOP is an optional component to give your CAL door even better thermal characteristics during installation. TOP has been specially designed to be fully integrated with the CAL standard thermally broken threshold. The addition of the TOP component gives even better performance to your door.

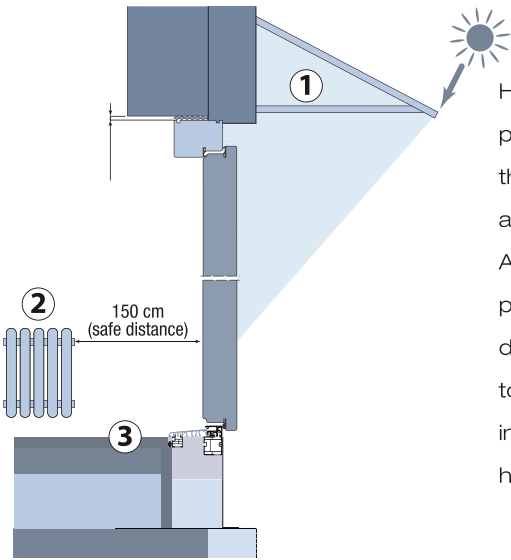

High quality products also require a perfect installation. CAL was one of the first manufacturers to introduce an insulated threshold assembly. A careful, well done installation protects the door from long term damage, and also allows the door to do what it was designed to do: insulate the house from the cold (or hot) outside.

**1. - ROOFING.** Exterior doors should be protected from direct precipitation and sun influence by putting them in niches, or by using roofing to cover doors mounted in straight walls. Roofing should extend beyond the outline of the open door and protect the door against direct sunlight at noon, during the summer.

**2. - HEAT SOURCE.** The minimum distance from the heater to the door should be 150 cm.

**3 - INSTALLATION.** Wooden exterior doors should be installed after the "wet" construction works inside the building, such as plastering and flooring works, are completed and dried.

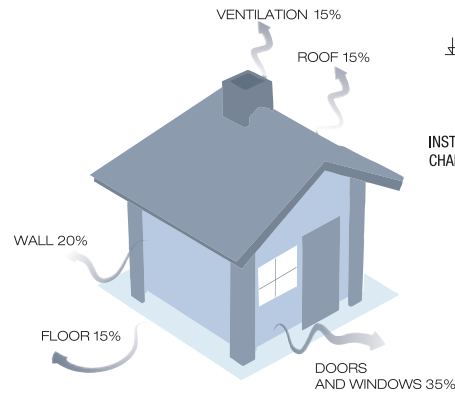
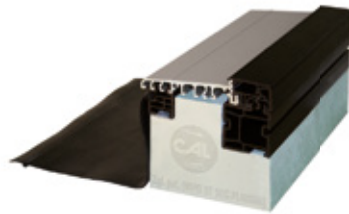

TYPICAL SCHEDULE OF HEAT LOSS IN THE BUILDING:

CAL doors installation options: determined by the building construction.

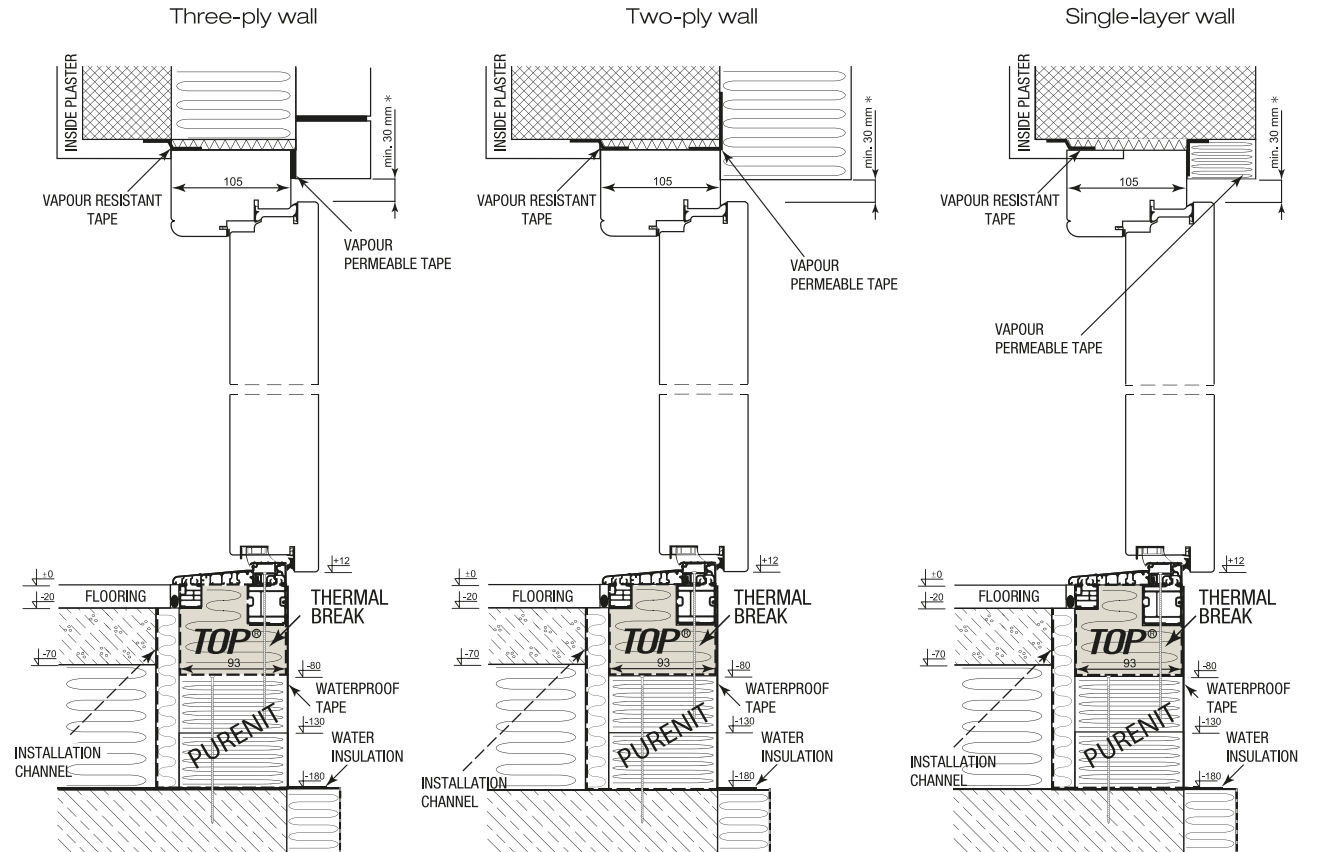

\* Minimum distance required to remove the door off of the hinges

## CARE SET



We highly recommend that you protect your beautiful new door 2-3 times a year. We can provide a dedicated product for this purpose (remember, Alkaline detergents or solvents must not be used).

The Ottimo Door Care set is intended for cleaning, refreshing and regenerating the door surface. These solutions may be used on surfaces of both external and internal doors. The water-based formula are environmentally friendly.

- Care set includes:
- door cleaner (250 ml)
  - door refresher (250 ml)
  - cloths (2 pcs)

## THERMAL THRESHOLD BEAM - TOP®

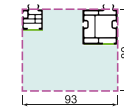

Set includes:

1. Support block 35x35mm
2. Support block 20x20mm
3. Milled block of extruded hard polystyrene 80x93 x [width of the door] with two strips of butyl tape
4. Waterproofing membrane - width 200mm

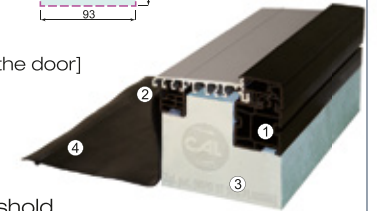

The set attaches directly to the 100 mm aluminium threshold. When ordering pre-manufactured doors, please specify the total width of the door (including sidelights) or number of order of the door.



A SOUND FOUNDATION FOR TOP® - this solid piece made of PURENIT® is a structural element that provides extremely good insulation and structural performance. This component is 1200mm long and 50mm thick. It can be easily cut, drilled, or shaved with universal tools and installed during construction. It allows the builder to achieve level ground under the door TOP® at the level of -80 mm (see illustration on page 44). Only Purenit - a German insulating material formed of a combination of polyurethane foam and aluminium shavings is characterized by a high resistance to chemicals, moisture and fungi. Its properties also include high resistance to compression and excellent thermal insulation. No other material provides such thermal or mechanical properties for many years service with TOP.

PURENIT dimensions HxWxL: 50x95x1200mm / 1 pc.

## ISO-BLOCO One 74/5-30

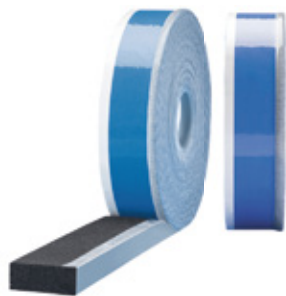

The ingenious 3-in-1 solution for 100 % joint airtightness. Where three products used to be required, one is now enough: ISO-BLOCO ONE. The multi-functional joint sealing tape with outstanding three-level functionality is 100 % air tight and vapour-resistant on the inside, provides thermal and sound insulation in the centre and more than 1,000 Pa resistance to driving rain on the outside.

This product facilitates a quick and easy installation of the door. We recommend installation of this product at +10C and above allow for proper expansion of the tape.

For CAL frames we recommend ISO-BLOCO One 74 / 5-30

- Tape width: 74 mm
- Thickness before decompression: 5 mm expands to 30mm
- Long expansion time allows for accurate installation

ISO-BLOCO ONE 74/3-18 (6 meters per roll)

## ISO-CONNECT Vario SD

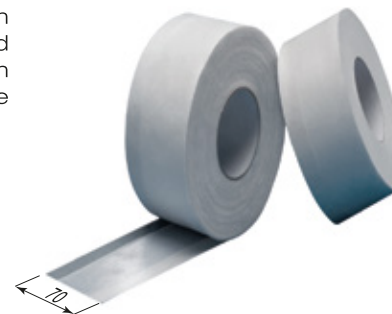

The innovative special tape with the variable sd-value ISO-CONNECT VARIO SD has unusual properties. The innovative window/door connection tape adapts to the seasonal temperature and vapour diffusion gradients which occur from the inside outwards or the outside inwards. Thus ISO-CONNECT VARIO SD belongs to a completely new generation of tapes which guarantees dry joints all year round, banning mould from the connection joint and sealing the joint in an energy-saving manner.

ISO-CONNECT Vario SD (15 meters per roll)

Please note: Polyurethane foam and similar insulation materials are NOT intended to replace mechanical fasteners, but rather only for sealing and insulation of gaps between the door and the wall.



Pull bar PS-W

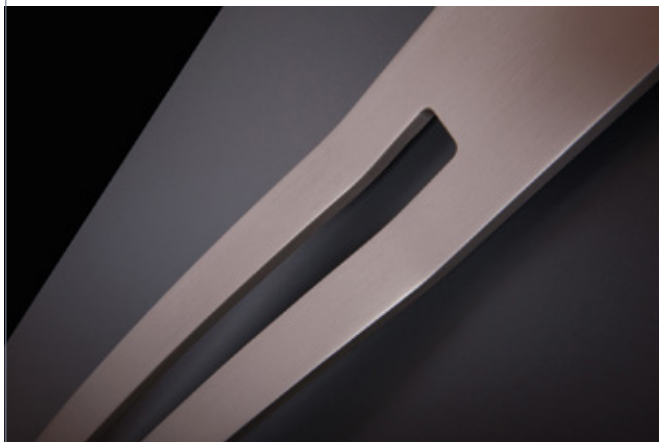

Pull bar Q 10 / Q 45



Pull bar QS

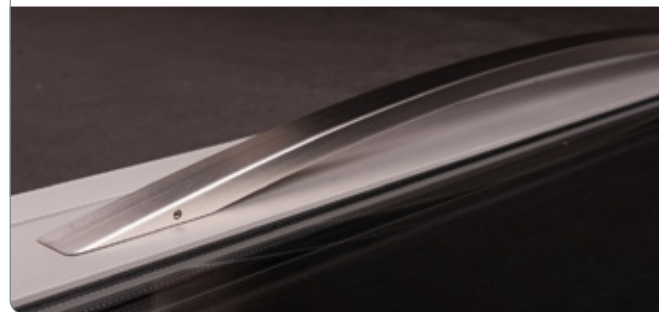
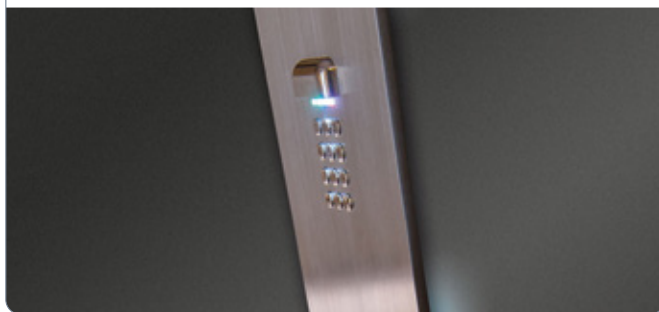
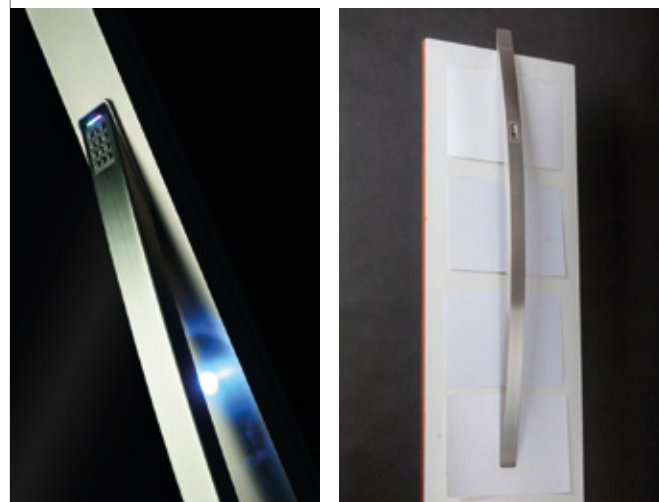
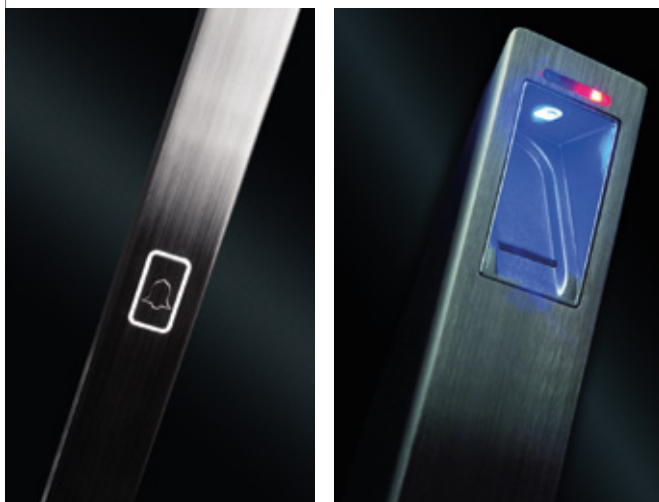
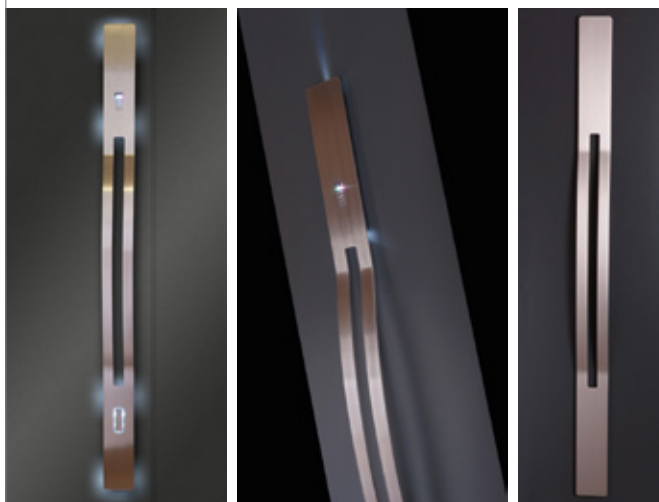
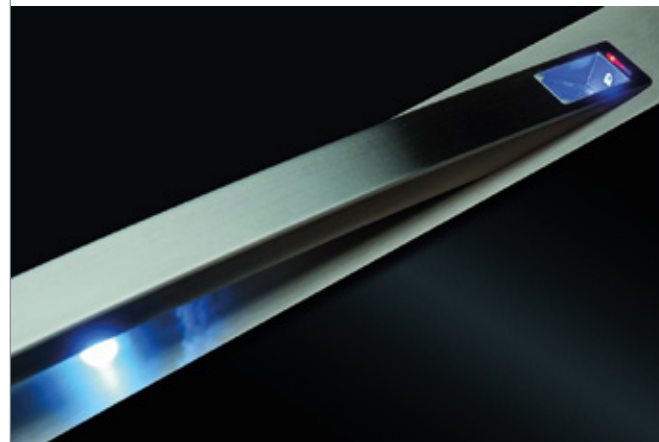

# INTERIOR DOORS

COMPLETE YOUR PERFECT CAL FRONT DOOR WITH EQUALLY GOOD INTERIOR DOORS

CAL interior doors are the quintessence of elegant design. Different versions - full, partially or fully glazed - allow to adjust the appearance of the wings to fit the functions of the room. Full offer is available in the catalogue of CAL Interior Doors, and if you still cannot find the door for you there, please check our website at: [www.drzwi-cal.pl](http://www.drzwi-cal.pl). There, you can easily design your own style with use of our user-friendly online configurator) and CAL will prepare a door for you.

**CAL interior oak door will make your house:**

- Beautiful - the "tailoring" process allows you to create subtle decorations, which match different styles of interior design;
- Perfectly useful - whether extra doors, double doors, or sliding doors, they are all designed to use the space of your home in best way;
- Durable - the children can play freely. Thanks to using wood, most of the damage can be easily repaired without having to purchase new doors.







# FEATURES AND SPECIFICATIONS

<p>Door cross-section</p>  <p>Door thickness Heat standard</p>	<p>90mm Arctic</p>	<p>90mm Thermo</p>	<p>78mm Thermo</p>																																																													
<p>Doors parameters U<sub>d</sub> - heat transfer coefficient R<sub>w</sub> - the weighted sound reduction index RC - burglar resistance class</p>	<p>U<sub>d</sub>=0,58 W/m<sup>2</sup>K R<sub>w</sub>=34 dB RC2</p>	<p>U<sub>d</sub>= 0,9 W/m<sup>2</sup>K R<sub>w</sub>=34 dB RC2</p>	<p>U<sub>d</sub>=0,9 W/m<sup>2</sup>K R<sub>w</sub>=34dB RC2</p>																																																													
<p>Collection / Page No.</p>	<p>Arctic collection / Page 22-25 Stone collection (Arctic) / Page 34-37</p>	<p>Luxury collection / Page 26-29</p>	<p>Knight collection / Page 12-17 Movie Stars collection / Page 18-21 Stone collection (Thermo) / Page 34-37</p>																																																													
<p>Standard lock</p>	<p>AV3</p>	<p>AV3</p>	<p>M2.1</p>																																																													
<p>Opening direction &amp; Euro cylinder size</p>	<p>Outward opening: 55/60Thumbturn Inward opening: 60/50Thumbturn</p>	<p>Outward opening: 55/60Thumbturn Inward opening: 60/50Thumbturn</p>	<p>Outward opening: 55/45Thumbturn Inward opening: 50/50Thumbturn</p>																																																													
<p>Standard frame sizes</p> <p>* frame narrowing (free of charge)</p> <p>Door made according to standard PN-EN 14351-1:2006 + A1:2010</p>	<p>Dimensions [mm]</p> <table border="1" data-bbox="512 1251 1060 1345"> <thead> <tr> <th rowspan="2">Size</th> <th rowspan="2">Width</th> <th rowspan="2">Hight</th> <th colspan="2">Recommended wall opening</th> </tr> <tr> <th>Width</th> <th>Hight</th> </tr> </thead> <tbody> <tr> <td>90</td> <td>1058</td> <td>2099</td> <td>1090</td> <td>2115</td> </tr> <tr> <td>90*</td> <td>1028</td> <td>2084</td> <td>1060</td> <td>2100</td> </tr> </tbody> </table>	Size	Width	Hight	Recommended wall opening		Width	Hight	90	1058	2099	1090	2115	90*	1028	2084	1060	2100	<p>Dimensions [mm]</p> <table border="1" data-bbox="1088 1251 1636 1345"> <thead> <tr> <th rowspan="2">Size</th> <th rowspan="2">Width</th> <th rowspan="2">Hight</th> <th colspan="2">Recommended wall opening</th> </tr> <tr> <th>Width</th> <th>Hight</th> </tr> </thead> <tbody> <tr> <td>90</td> <td>1058</td> <td>2099</td> <td>1090</td> <td>2115</td> </tr> <tr> <td>90*</td> <td>1028</td> <td>2084</td> <td>1060</td> <td>2100</td> </tr> </tbody> </table>	Size	Width	Hight	Recommended wall opening		Width	Hight	90	1058	2099	1090	2115	90*	1028	2084	1060	2100	<p>Dimensions [mm]</p> <table border="1" data-bbox="1665 1251 2199 1372"> <thead> <tr> <th rowspan="2">Size</th> <th rowspan="2">Width</th> <th rowspan="2">Hight</th> <th colspan="2">Recommended wall opening</th> </tr> <tr> <th>Width</th> <th>Hight</th> </tr> </thead> <tbody> <tr> <td>90</td> <td>1030</td> <td>2099</td> <td>1060</td> <td>2115</td> </tr> <tr> <td>90*</td> <td>1000</td> <td>2084</td> <td>1030</td> <td>2100</td> </tr> <tr> <td>80</td> <td>930</td> <td>2099</td> <td>960</td> <td>2115</td> </tr> <tr> <td>80<sup>1</sup></td> <td>900</td> <td>2084</td> <td>930</td> <td>2100</td> </tr> </tbody> </table> <p><small>1) Except models: Brygitte, Claudia, Ingrid, Katherine, Romy , Sophia</small></p>	Size	Width	Hight	Recommended wall opening		Width	Hight	90	1030	2099	1060	2115	90*	1000	2084	1030	2100	80	930	2099	960	2115	80 <sup>1</sup>	900	2084	930	2100
Size	Width				Hight	Recommended wall opening																																																										
		Width	Hight																																																													
90	1058	2099	1090	2115																																																												
90*	1028	2084	1060	2100																																																												
Size	Width	Hight	Recommended wall opening																																																													
			Width	Hight																																																												
90	1058	2099	1090	2115																																																												
90*	1028	2084	1060	2100																																																												
Size	Width	Hight	Recommended wall opening																																																													
			Width	Hight																																																												
90	1030	2099	1060	2115																																																												
90*	1000	2084	1030	2100																																																												
80	930	2099	960	2115																																																												
80 <sup>1</sup>	900	2084	930	2100																																																												



# PRICE COMPARISON SHEET

Check out what you get for your money. Compare our prices (with standard features) to others and see if it includes the same features.

Heat standard			Arctic	Thermo	Comfort	Manufacturer 1	Manufacturer 2	Manufacturer 3		
Safety		Choose your CAL door, enter the price and compare with other Manufacturer								
RC3 Security Package	RC2+ Security Package	RC2 Electro Security Package	RC2 Security Package	<b>Door</b> Thickness: Luxury collection 90 mm * Alutherm collection (Arctic) 94 mm Construction: ** Alutherm collection (Thermo) 82 mm Material:	90* mm Flush door Pine Oak Pine core - Oak cladding	78** mm Flush door Pine Oak Pine core - Oak cladding	65 mm Panel door Pine Oak -			
				<b>Frame</b> Depth x Width: *** doors made of oak or pine with oak finish always with oak frame Material:	105x65 Pine Oak**	105x65 Pine Oak**	105x65 Pine Oak**			
				<b>Hinges</b> Ø20 mm adjustable in 3 directions	4 hinges	4 hinges	4 hinges			
				<b>Airtightness</b> Triple or double rebated door	Class 4 Triple rebated	Class 3 Double rebated	Class 3 Double rebated			
				<b>Lock</b> Winkhaus multi-point security lock	3-point lock (AV3)	3-point lock (M2.1)	3-point lock (M2.1)			
				<b>Adjustment</b> Fine and smooth adjustment in 3 directions. (vertical, side-to-side, depth adjustment)	3D	3D	3D			
				<b>Security Class</b>	RC2	RC2	RC2			
				<b>Heat Transfer Coefficient</b>	0,58	0,9	1,3			
				<b>Glass</b> low-E security glass, reflective, clear, milk, frosted, one-way mirror	Triple glazed Ug = 0,5 [W/m²K]	Triple glazed Ug = 0,5 [W/m²K]	Double glazed Ug = 1,1 [W/m²K]			
				<b>Threshold</b> thermally broken low aluminium threshold with an additional 80mm Thermal Doorstep Beam	Aluminium-PCV	Aluminium-PCV	Aluminium-PCV			
				<b>Burglar resistance class</b> Anti-burglar protection "French rebate" (CAL's innovation)	Yes	Yes	Yes			
				C Class single insert three point lock, RC2 certified	Yes	Yes	Yes			
				Winkhaus branded electrically driven automatic lock including door installation, RC2 certified	surcharge	surcharge	surcharge			
An additional locking insert (not available with RC2 ELECTRO), RC2 Certified	surcharge	surcharge	surcharge							
Five point lock with independent quick lock system (not available with ELECTRO), thick steel plates on both sides of an insulating core, 4 reinforced hinges, reinforced frame, set of anti-burglary accessories (door handle, escutcheon, C class inserts), RC3 Certified	N/A	surcharge	N/A							
	THERMAL THRESHOLD BEAM - TOP ®	surcharge	surcharge	surcharge						
52	TOTAL									



# ACCESSORIES

### EURO CYLINDER

"B class" (Security Standard)      "C class" (Security Standard)



Cylinder colour: brass or chrome  
Thumbtum colour: F4 old gold, F8 black, F6 stainless steel, F9 titanium,  
5 keys included

### ACCESSORY SETS

EKONO set      PRESTIGE set



Set includes:  
- Manitoba Plus handle (F4, F6)  
- non-certified cylinder (chrome, brass)  
- 3 keys

Set includes:  
- Prestige handle (F4, F6)  
- Keyed alike euro cylinder "C class" set (chrome, brass), one cylinder with thumbtum (F4, F6),  
- 5 keys  
- Hinge covers (F4, F6)

### HANDLES

Colour: F4 old gold, F6 stainless steel, F8 black, F9 titanium  
Option: lever handle or with grip  
Spacing (center-to-center measurement): 92 mm

**PRESTIGE**  
F9 titan  
F8 stainless steel  
F4 old gold



**DIVA**  
F4 old gold  
F6 stainless steel  
F9 titan



**SOLID**  
F6 stainless steel  
F4 old gold



**TORONTO**  
F6 stainless steel  
F4 old gold



**JUPITER**  
F8 black  
F6 stainless steel  
F4 old gold



escutcheon

Special escutcheon for the M3.1.1 lock  
F6 stainless steel colour only

### EURO CYLINDER SETS

"B class" (Security Standard)      "C class" (Security Standard)



Keyed alike euro cylinder set  
Cylinder colour: brass or chrome  
Thumbtum colour: F4 old gold, F8 black, F6 stainless steel, F9 titanium  
5 keys included

### DOOR VIEWER

Colour: brass, chrome



### HINGE COVERS

Colour: F4 old gold, F6 stainless steel, F8 black, F9 titanium



### DOOR KNOCKER

Colour: F4 old gold



### DOOR STOPPER

Colour: F4 old gold, F6 stainless steel, F8 black, F9 titanium



raise by 15 mm  
raise by 30 mm

### REED SWITCH



M2.1    M2.1.1    M3.1.1    AV3    eAV3



M2.1 multi-point lock / 1 cylinder / 3 points locking  
Cylinder activates two hooks and the main deadbolt  
M2.1.1 multi-point lock / 2 cylinders / 4 points locking  
Bottom cylinder activates two hooks and the main deadbolt.  
Upper cylinder activates the additional deadbolt.  
M3.1.1 multi-point lock / 2 cylinders / 5 points locking  
Bottom cylinder activates three hooks and the main deadbolt.  
Upper cylinder activates the additional deadbolt.  
The lock was tested on the RC3 class CAL door.  
NOTE: The lock is only compatible with the Toronto handle and eschuteon.  
AV3 multi-point auto lock / 1 cylinder / 3 points locking  
By pulling the door closed, the sealing elements, hooks and the latch are triggered by means of a magnetic release on the frame. Cylinder is to activate only the main deadbolt.  
EAV3 multi-point auto lock / integrated motorised opening function / 1 cylinder / 3 points locking  
Operates like AV3 lock. Door can be opened by handle, cylinder or electric devices presented on page 46 or any other compatible. 12V power pack included.

Collection Lock	Luxury	Movie Stars Knight	Arctic	Classic	Stone Alutherm
M2.1	SF	STD	SF	STD	STD
M2.1.1	SF	CHG	SF	CHG	CHG
AV3	STD	CHG	STD	CHG	CHG
EAV3	CHG	CHG	CHG	CHG	CHG
M3.1.1	SF	CHG	CHG	CHG	CHG

STD- standard equipment, SF- equipment without surcharge, CHG- equipment with surcharge

### ONE-SIDED PULL BAR

In the Classic and Luxury collection, only the angle mounted bar available.

#### AXA PULL BAR

Colour: F4 old gold, F6 stainless steel, F8 black, F9 titanium  
Length: 1000, 1200, 1500, 1700



Rectangular Pull Bar  
right angle mounted



Rectangular Pull Bar  
angle mounted



Round Pull Bar  
right angle mounted



Round Pull Bar  
angle mounted

AXA pull bars use push-through installation.  
There are two covers on the inside

JUPITER SOLO



### TWO-SIDED PULL BAR

In the Classic and Luxury collection, only angle mounted bars available.

#### AXA PULL BAR

Colour: F4 old gold, F6 stainless steel, F8 black, F9 titanium  
Length: 1000, 1200, 1500, 1700



Rectangular Pull Bar  
right angle mounted



Rectangular Pull Bar  
angle mounted



Round Pull Bar  
right angle mounted



Round Pull Bar  
angle mounted

MARS SOLO PREMIUM\*



DIANA SOLO PREMIUM\*



SLIM SOLO SPEC



Colour: F4 old gold, F6 stainless steel, F8 black, F9 titanium

### DAYTIME LATCH

This disables the autolock (multipoint) function of the door.  
Allows the door to be used like a "balcony door".

The door can be simply pushed or pulled open. For doors up to 2200mm in height. Cannot be used in public building or with double doors. Self closer is required.

Please note: daytime latch in active mode means that the door is not tightly closed.



### CONCEALED DOOR CLOSER



Using a closer improves the operation of the daytime latch device.  
It is installed completely inside the door leaf. The guide rail and closer arm can only be seen when the door is open. It can be used for doors without daytime latch, as well.

DIVA SOLO



SOLID SOLO



SLIM SOLO





Colour: F4 old gold, F6 stainless steel, F8 black (only for Jupiter handle),  
F9 titan Spacing - 92 mm

# ADDITIONAL UPGRADES

## KNOTTY OAK

For centuries, oak has invariably been considered a symbol of wealth and prosperity, a status symbol. Knotty Oak goes even further. Exceptionally elegant and unique, it comes with an interesting rustic texture. Made of Knotty Oak, your door is bound to attract the attention of visitors, while lending extra quality, style and appeal to your home.



Available in every collection, except Classic series.

## MOVIE STARS COLLECTION

### Standards:

- "Step Glass" triple-glazed units completed with black tempered pane, 5 mm thick and beveled on the edges
- Black kick plate at the base of the door
- Model Brigitte: five triple-glazed units with 5mm "Step Glass" and vertical black steel plate on the lock side

### Options:

- one-way mirror
- stainless kick plate
- door without kick plates (no surcharge)

## CAL CASING SYSTEM

Option available only with outward opening door

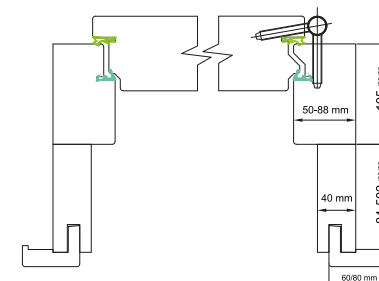
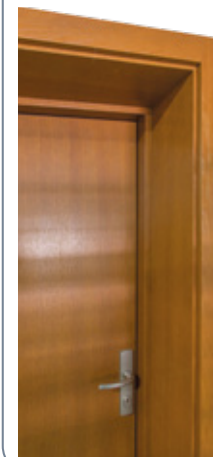

Hit! Without surcharge - Best Price!

## PINE CORE - OAK CLADDING

Pine door design allows to keep better thermal insulation provided by pine wood. The oak veneer used on the outer wing plane, gives the door a noble character and allows the customer to choose between popular colours for example: golden oak or „Winchester.“ The oak frame provides a solid foundation for mounting the door. The shades may differ on door rebate due to the use of different materials.

## LEVEL RAISER

Additional frame extension. Allows to increase a door frame height from 50-180mm. Flat beam for the extensions from 50-160mm. Flat beam with decorative element mapping the door leaf only for the extensions from 160-180mm.



For single door only

## GLASS OPTIONS

Standard glazing: Low-E, security reflective bronze glass

### Other options:

- reflective graphite glass
- one-way mirror glass
- clear glass
- milk glass
- sandblasted glass
- stained glass

## RC3 CLASS

The design is based on our standard oak, opaque flush door 78mm thick (Knight collection), equipped with fittings and reinforcements that satisfy specified RC3 class of burglary resistant construction, and it's proven with appropriate certificate, as well. All of our RC3 doors are equipped with: thick steel plates on both sides of an insulating core; multipoint lock (five points locking), four heavy-duty hinges, reinforced door frame construction and set of certified accessories (door handle and two cylinders)

Please note: RC3 class system can not be used with CAL CONNECT (Page 46)

## "COMFORT-PLUS"

Reinforced construction of stiles as a standard for all collections. It is to increase the rigidity of the door and to prevent it from warping.

Flush door: 3 aluminium profiles within stiles - hinge stile 1 profile, lock stile 2 profiles.  
Panel door: 4 aluminium profiles within stiles - hinge stile 2 profiles, lock stile 2 profiles.



Flush door



Panel door

## KICK PLATE

A stainless steel plate at the base of a door to protect it from damage or wear



## SIZE "100"

frame inner width of 1000mm



ZSB CAL Sp. j.  
Z. Cywilński i wspólnicy spółka jawna  
ul. Piaskowa 5, 16-400 Suwałki, Poland  
Tel. +48 87 563 11 55  
www.drzwi-cal.pl

#### SALES DIRECTOR

Czesław Suski  
+48 87 563 11 17  
+48 501 561 555  
biuro@drzwi-cal.pl

#### HEAD OFFICE

Urszula Masłowska  
+48 87 563 11 16  
umasłowska@drzwi-cal.pl

#### SALES DEPARTMENT

+48 87 563 11 14, +48 87 563 11 32  
zamowienia@drzwi-cal.pl

#### \* EXPORT MANAGER \*

Grzegorz Kosiński  
+48 87 563 11 09  
+48 535 695 300  
gkosinski@drzwi-cal.pl

#### MARKETING

Paweł Krzeziński  
+48 87 563 11 33  
pkrzeziński@drzwi-cal.pl

#### REGIONAL SALES MANAGERS

1. Andrzej Mecmajer, +48 695 339 088, amecmajer@drzwi-cal.pl
2. Leon Suski, +48 501 555 899, leon@drzwi-cal.pl
3. Robert Ciszewski, +48 784 784 390, robert@drzwi-cal.pl
4. Robert Ciszewski, +48 784 784 390, robert@drzwi-cal.pl

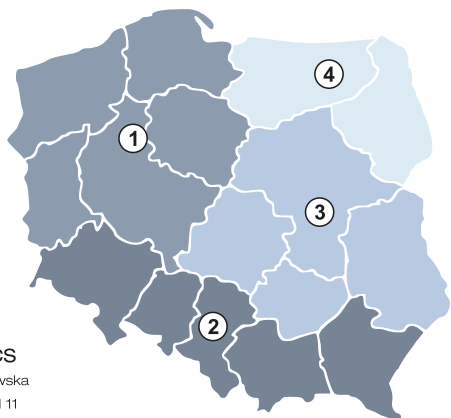

#### LOGISTICS

Iwona Kotkowska  
+48 87 563 11 11  
ikotkowska@drzwi-cal.pl

CAL's points of sales available on [www.drzwi-cal.pl](http://www.drzwi-cal.pl) tab 'siec sprzedazy'.

Each point of sales is marked per door's category exposition : external, internal and authorised installation group.

UNIQUE DOORS  
FOR A UNIQUE HOME  
*- Always with the CAL logo,*



BUSINESS PARTNER

Information included in this catalogue are not an offer in respect of the Civil Code. Considering variations from the colors represented here can occur, subject to printing techniques. The color differences, rings and structure made their original live material's character which is wood and cannot constitute a basis for complaint. Illustrations, technical information, data and descriptions included in this catalogue had corresponded to the actual condition during the time that the catalogue was printed. We reserve a right to include (without permission) change of dimensions, technical parameters, inventory and product's improvement included in this catalogue. We are pursuing improvements and developments of our products. Before embedding the door in the hole, use the assembly instruction to familiarize yourself. Despite every effort in order that this publication will contain full and precise information, we are responsible for any lacks or errors - which could appear in this catalogue. This catalogue do not set prices. The catalogue become effective since 01/03/2018. As of 01/03/2018 every previous CAL publications concerning the same products has expired.

ATTENTION ! Every CAL products are produced for individual consumer's order and equipped according to its wishes.