

INTERIOR DOORS CATALOGUE

Just the way you want them



Get backstage to find out more about our manufacturing process.
Discover over 100 inspirations inside our catalogue.

Contents

04 Inspirations

10 Collections

- 10 Op-art
- 14 Loft Collection
- 18 La Linea Collection
- 24 Nova 3.1 Collection
- 30 Noble Collection
- 36 Geometry Collection
- 42 Classic Collection
- 48 Nova 3.0 Collection
- 54 Luxury Collection

60 Technical Information

- 60 CAL Colour Chart
- 62 Handles
- 64 Accessories
- 65 Glazing
- 66 Door Structure. Nature in Your Home
- 67 Selected Work
- 68 Doorframes
- 70 Frameless Doors
- 71 Sliding & Pocket Doors
- 74 Reversible doorframes
- 75 Still More Nature

76 Door Size Guide

78 Additional Options

Door features

Doorframe

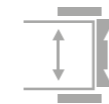

Adjustable - unit with casing already installed, and you also get some wiggle room on coving wall thickness

Rebated - single-piece profile jamb with an integrated door stop



Architraves

60mm/80mm for an adjustable doorframe, no mitering needed

60mm/108mm for a rebated doorframe, mitering needed

Door structure



Panel doors

Frame and panel structure where mortise and tenon joint is employed to fix rails and stiles



Flush

Solid wood door or low density fibreboard door



Tailored

Wide range of styles for all project types, including custom sizes, designs, finishes, etc.



Double doors

Equal or unequal double leaf doors

Door type



British Style hinged door set

Doors flush with frame



European Style hinged door set

Doors are framed with a rabbeted jamb



Reversible door

Doors are framed with a reversed rebate jamb



Swing and Slide System

Doors fitted with ERGON® pivoting-sliding hardware kit



Sliding

wall-mounted and/or pocket door



Frameless door

Flush-to-wall door

Door finishes



Oak Transparent Finish

stained and varnished or oiled



Oak Painted

RAL or NCS, with oak grain



Smooth Painted

RAL or NCS, no wood grain

Inspirations



1/4 | model: Soplca 2p
colour: RAL 6005



1/5 | model: Okmin 1s
colour: RAL 9003 smooth painted



2/4 | model: Lord left
colour: RAL 9005 X-mat



3/4 | model: Tango 13 with a retro doorframe and a crown
moulding | colour: RAL 9003



2/5 | model: Jaczno 01
colour: RAL 4010



1/6 | model: Matera
colour: RAL 9005 X-mat



1/7 | model: Boksze 10 | Height: 2.5 m
colour: RAL 9003 smooth painted |
handle: Nova 3.1



2/6 | model: Zosia 1s with an adjustable doorframe
and crown moulding | colour: RAL 9003 smooth
painted | frosted laminated glass



3/6 | model: Iluzja | Height: 2.5 m
colour: Oiled oak | doorframe: RAL 9005 X-mat



2/7 | model: Hańcza
colour: RAL 9003 smooth painted

You want it to be beautiful, quiet, and secure.
You want it to express your tastes, desires, and your values. It should be a place where good emotions and honest gestures are born. It should never lack warmth. It should simply be a home.

A home needs a real door. The kind of door that will help turn a house into your home. A door made of real wood, harvested in harmony with nature, that is in harmony with you and your care for your loved ones and the planet. The kind that has been made by human hands which treated the raw material like a treasure, with love. Robust and durable like family ties because they have been designed with every challenge in mind. Guarding the warmth and calm that you need so much when you come back home from a cold and busy world. The kind of door that follows your style. The kind that you have always dreamed of. We have turned that dream into reality.

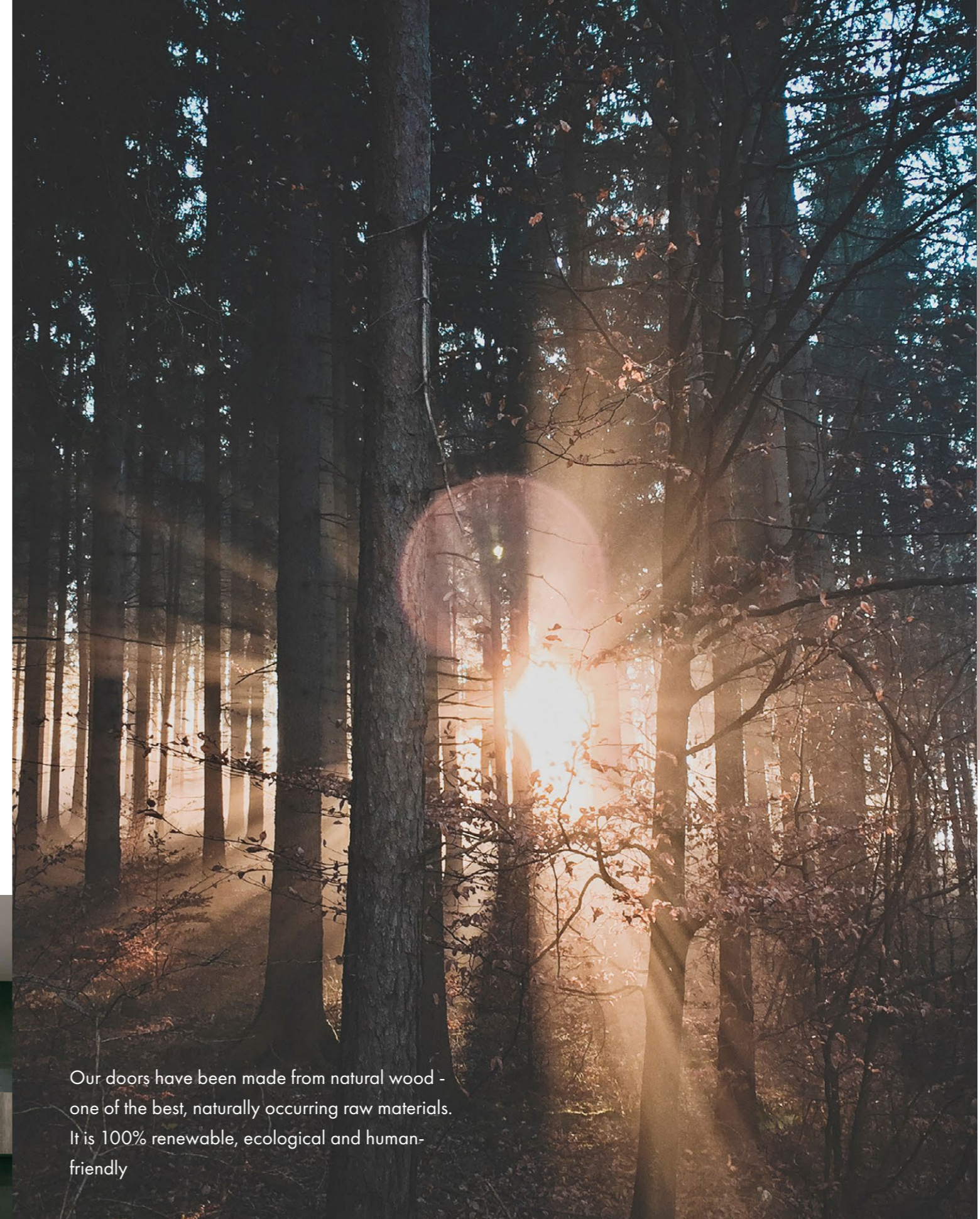

Our doors have been made from natural wood - one of the best, naturally occurring raw materials. It is 100% renewable, ecological and human-friendly



Op-art



Op-art Collection

Optical art, whose function is to influence the eye of the beholder, can also find a way to your home. Geometric patterns, sometimes orderly and sometimes engaging us in a game of illusions, are a welcome addition to avant-garde interiors.

The most important distinguishing feature of this collection is the deep black milling, which gives the doors a unique character and a three-dimensional effect. These intricately crafted designs are more than just a form of artistic expression - they also enhance the natural beauty of the wood.

A door leaf is protected with oil wax to underline the exquisite oak tree ring pattern. The frame of this optical collection is usually finished in elegant black (the unique RAL 9005 x-mat colour). A natural oak doorframe can be combined with a contrasting door leaf. Both solutions are included in the price of the door.

The interior doors in the Op-art collection are always made of oak, with natural veneer protecting the natural wood inside the door, where you will find no chipboard or honeycomb paper. It is a functional door and a work of art that will add a unique style to any interior.

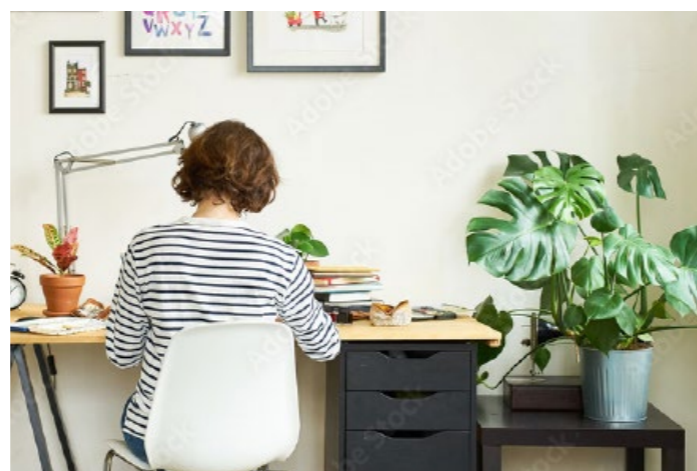

Dynamika

- Material: Oak
- Door: OW3032
- Doorframe: RAL 9005 X-mat

3500 zł netto



Fuzja

- Material: Oak
- Door: OW3032
- Doorframe: RAL 9005 X-mat

3500 zł netto

Harmonia

- Material: Oak
- Door: OW3032
- Doorframe: RAL 9005 X-mat

3500 zł netto



Standard option Extra-cost option

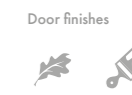
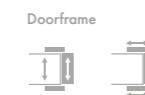
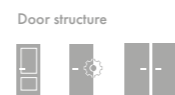



Op-art

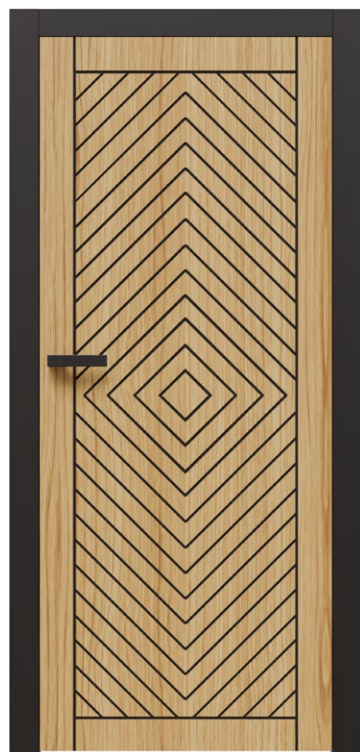

Iluzja

- Material: Oak
- Door: OW3032
- Doorframe: RAL 9005 X-mat

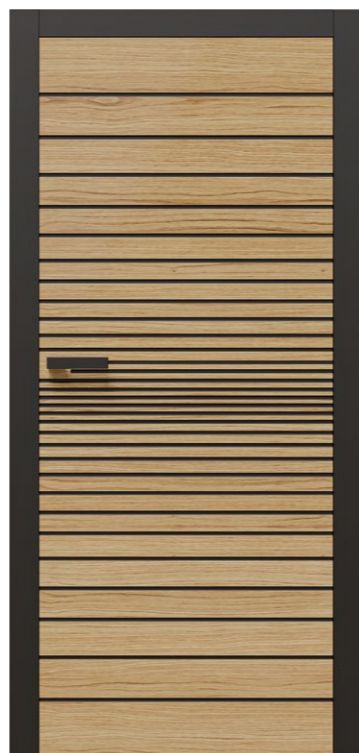

Kinetyzm

- Material: Oak
- Door: OW3032
- Doorframe: RAL 9005 X-mat



Symetria

- Material: Oak
- Door: OW3032
- Doorframe: RAL 9005 X-mat



Rytm

- Material: Oak
- Door: OW3032
- Doorframe: RAL 9005 X-mat



Optyka

- Material: Oak
- Door: OW3032
- Doorframe: RAL 9005 X-mat



Zebra

- Material: Oak
- Door: OW3032
- Doorframe: RAL 9005 X-mat

Standard option Extra-cost option

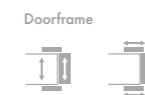
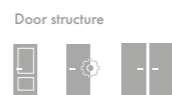



Loft Collection

Doors are some of the most fascinating objects in life and literature.

A door can be opened to possibilities, or closed to shut something out.

In loft-style interiors, a door is an interconnection element of all formal organization of indoor space designed to accommodate the private and social areas.

What's all the rage this season in loft design? Real wood & glass doors. Talk about oak frame structure doors with glazing as their dominant component. At CAL, they are also available in the ultra cool X-matte colour.

The Loft collection from CAL is intended for apartments arranged in former industrial buildings, like factories or warehouses, or for a large, high and open living space, designed in an industrial style and brightened up with glazed CAL doors which let light through.

Their names are truly royal and so are their components. If you are looking for modern designs and, at the same time, want to enjoy the touch and the beauty of wood, the Loft collection from CAL has been made just for you.

The doors from this collection come complete with a magnetic lock, a window pane and are available in the full range of stain colours: spray stain, rubbed-in stain, and wax oil, as well as the full RAL colour palette.



Cesar loft

- Material: Oak
- Colour: RAL 5009
- Frosted laminated glass



King loft

- Material: Oak
- Leaf colour: WO 3032
- Doorframe colour: RAL 9005 X-matte
- Frosted laminated glass

Lord loft

- Material: Oak
- Colour: RAL 9005 X-matte
- Frosted laminated glass

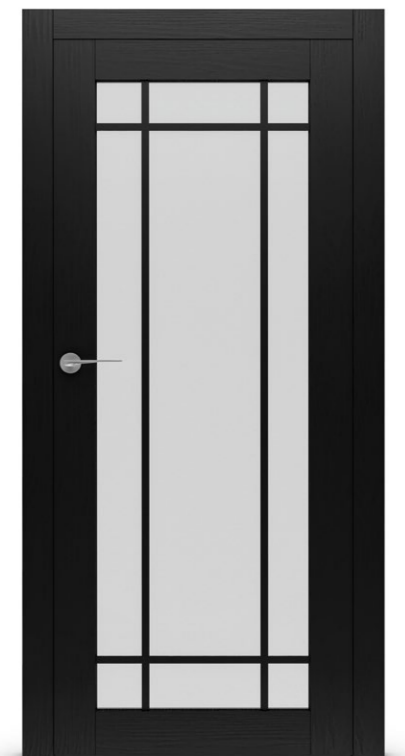

Standard option Extra-cost option

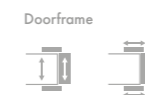
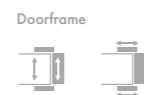



Loft Collection



Prince loft

- Material: Oak
- Colour: RAL 7024
- Frosted laminated glass



Sultan loft

- Material: Oak
- Colour: RAL 6004
- Frosted laminated glass



Queen loft

- Material: Oak
- Colour: RAL 9003
- Frosted laminated glass



1/13 | model: King loft
 colour: Oak RAL 9005 X-matte | handle: La Linea | clear laminated glass



2/13 | model: Lord loft
 colour: Oak RAL 9005 X-matte | handle: La Linea | clear laminated glass

Standard option
 Extra-cost option

Door type:
 Doorframe:
 Door structure:
 Door finishes:

La Linea Collection

Meet a new line of CAL interior doors made in tribute to the Italian people.

The Italian genius has conquered the world with quality, fantasy, and ingenuity. Famous for its small craft workshops, the country is an oracle of design and its crafts are a source of nonpareil inspiration for the CAL brand. Let us unveil before you a world of functional and minimalist yet elegant doors from this collection which is inspired by beautiful Italian cities. Bella Italia. That's the place we love the most.

The collection contains 12 unique designs featuring fancy cuts. The flexibility of this line creates countless possibilities of personalization leading to very original doors.



Bari

Colour: RAL 7047 smooth painted



Como

Colour: RAL 9016 smooth painted



Lucca

Colour: WO 3032

Standard option Extra-cost option

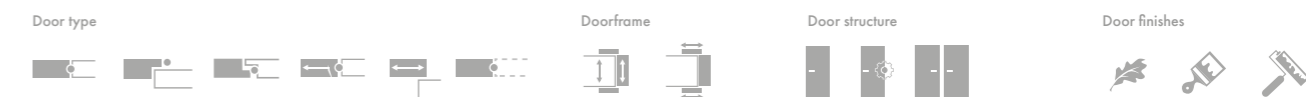



Matera

Colour: RAL 9005 X-matte



Pisa

Colour: RAL 7040 smooth painted



Siena

Colour: WO 3032



Roma

Colour: RAL 9016



Amalfi

RAL 9003 smooth painted

X-matte 9005

Deep black without gloss. Black interior doors in a gorgeous X-matte 9005 finish look particularly impressive when paired with white walls. An additional feature of this coating is that normal use leaves no finger-prints or smudges, which will be appreciated by those who have dealt with traditional black paints. X-matte 9005 is the only black coating available for interior doors.

Standard option Extra-cost option

Standard option Extra-cost option

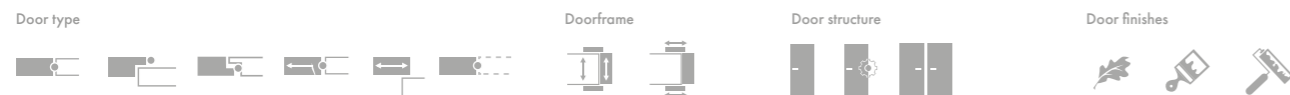



Venezia

Colour: RAL 5022



Vinci

Colour: WO 3188



Verona

Colour: RAL 9001 smooth painted



Volterra

Colour: RAL 6004

Colours

CAL doors offer an unending feast of colours. From almost all RAL and NCS colours for satin, glossy or X-matte surfaces through the same colours for the visible oak grain to clear colours for water-based paints and wax oils that highlight the natural beauty of oak wood.

Door, Leaf, Doorframe, Hinges, Locks

A door is a system consisting of a leaf (a movable element), a doorframe (mounted in the wall opening), hinges (connecting the two previous elements) and a lock (which closes it). In addition, there are decorative elements in the form of architraves (masking the connection between the frame and the wall) and a handle (door jewellery without which it is difficult to open the lock).

Standard option Extra-cost option

Standard option Extra-cost option





NOVA 3.1
Collection



NOVA 3.1 Collection

A door is an element of arrival and departure. It makes a simple and yet refined complement to your interior.

A modern structure is the principal trait of all unique, eco-friendly doors from the Nova 3.1 line. Their solid wooden core will, in turn, have a salutary impact on the microclimate in your home. The doors from this collection are painted in single colour satin, including the timeless white door! Fans of raw timber may choose knotty oak veneer secured with wax oil. Some models go as far as to combine materials that are seemingly worlds apart: only this collection presents trendy walnut veneer and aluminium inlays in a white leaf.

If you appreciate the beauty of simple doors – this collection is meant for you.

Choose a simple room door from the Nova 3.1 Collection. Exceptional designs. A modern look. Fully eco-friendly and made using the panel door structure.



Boksze 10

- Veneer: Knotty oak
- Colour: WO 3032
- Doorframe: RAL 9005 X-matte



Boksze 20

- Veneer: Knotty oak
- Colour: WO 3032

A concealed doorframe

Some interior designs are based on absolute minimalism. Even the most modest doorframe or a skirting board may disturb the harmony of the indoor space. In such cases, we use concealed frames that will perfectly blend in with the surroundings.

Standard option Extra-cost option

Door type



Doorframe



Door structure



Door finishes



Door type



Doorframe



Door structure



Door finishes





NOVA 3.1
Collection



Bokszo 10

- Colour: RAL 9003 smooth painted



Bokszo 10B

- Veneer: Knotty oak
- Colour: OW 3032
- Doorframe: RAL 9005 X-matte
- Frosted laminated glass



Jaczno 01

- Colour: RAL 5001
- Acid-etched toughened glass



Bokszo 31

- Doorframe: RAL 9005 X-matte
- Gold metal inlay

Door conflict

This is not a title of a feature story by Ryszard Kapuściński. It is a situation where, in a cramped room, open doors collide. This is dangerous both for the door and for the users' fingers. The problem can be remedied by selecting the appropriate opening directions or by alternating reversible doors with traditionally opening doors (p.68).

How to take care of CAL doors?

Our doors are practically maintenance-free. It is recommended to protect the surface of the door 2-3 times a year with generally accessible wood care products. In the case of oiled doors, apply wax oils. Please be reminded that alkaline and solvent-based products cannot be used.

Standard option Extra-cost option

Standard option Extra-cost option

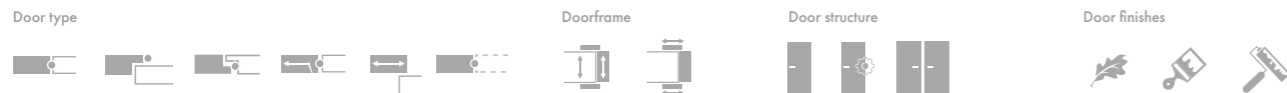



Jaczno 03

- ⦿ Colour: RAL 9003 smooth painted
- Ⓢ Acid-etched toughened glass



NOVA 3.1
Collection



Jaczno 06

- ⦿ Colour: WO 3188
- Ⓢ Acid-etched toughened glass



Jaczno 04

- ⦿ Colour: RAL 3001
- Ⓢ Acid-etched toughened glass



Jaczno 08

- ⦿ Colour: RAL 6005
- Ⓢ Acid-etched toughened glass

Hinges for non-rebated door

A non-rebated door is a common name for a modern door with a concealed rebate where the leaf is flushed with the doorframe at least on one side. The hinges may be hidden in the rebate where they are 3D adjustable or they may be visible, allowing limited adjustability (a Scandinavian style, frequently encountered in the US).

Magnetic and mechanical locks

As a standard, CAL doors come (at no extra charge) with magnetic locks with a moving tongue. They are quieter in use than standard mechanical locks.

Ⓢ Standard option ⦿ Extra-cost option

Ⓢ Standard option ⦿ Extra-cost option

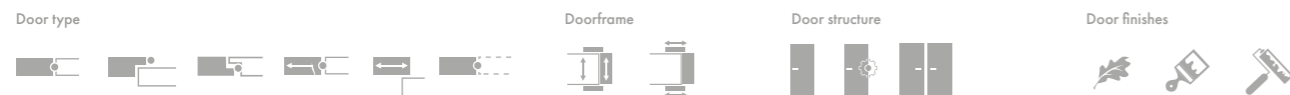



Noble Collection



Noble Collection

This collection celebrates beauty created in the vein of Polish nobility. Noble shapes and features. Models belonging to a higher class are embellished with unique wooden mouldings that lend unique charm and appearance. Built according to the exquisite tradition of extemporaneous doors. Classically alluring, pleasant to touch due to a satin finish, the doors from this range may also be used to articulate contemporary interiors. 100% filled with wood. Every trendy, modern nobleman would like to have them at his home.

The resilient structure of the doors from this line is based on timeless solutions. These leaves will survive years in phenomenal shape.



Protazy

Colour: RAL 9003 smooth painted



Protazy 1s

- Colour: RAL 9003 smooth painted
- Frosted laminated glass



Soplica 2p

Colour: RAL 9003 smooth painted

Standard option Extra-cost option

Door type



Doorframe



Door structure



Door finishes



Door type



Doorframe



Door structure



Door finishes





Noble Collection



Soplica 3p

⑤ Colour: RAL 9003 smooth painted

Soplica 1s

Colour: RAL 9003 smooth painted ⑤
Frosted laminated glass ⑤



Soplica 4p

⑤ Colour: RAL 9003 smooth painted



Tadeusz

Colour: RAL 9003 smooth painted ⑤

Tadeusz 4p

⑤ Colour: RAL 9003 smooth painted



⑤ Standard option ⑥ Extra-cost option

Wax Oils

They protect doors in two ways: the oil penetrates the wood protecting it from the inside against staining, the wax leaves a thin layer on the surface making it resistant to scratches and dents.

It has a shorter lifespan than varnish, but this is compensated for by the ease of repairing a minor damage. The presence of wax provides additional protection against scratching. Like oil, it is made from only natural ingredients.

For standard maintenance, use Osmo Wash & Care several times a year. Avoid using clean water or detergents. Use OSMO Liquid Wax Cleaner for minor repairs. Light single scratches can easily be repaired by hand by sanding the damaged surface and „oil waxing” it. Deeper scratches or damage should be repaired by a professional.

⑤ Standard option ⑥ Extra-cost option

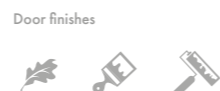



Telimena

● Colour: RS 05



Noble Collection



Zosia

● Colour: RAL 9003 smooth painted



Wojski

● Colour: RAL 9003 smooth painted



Zosia 1s

- Colour: RS 06
- Frosted laminated glass

● Standard option ● Extra-cost option

Wood – a natural raw material

By choosing real wood doors, you invite a part of the natural environment into your home with all the beautiful consequences that this act will entail. In the case of doors with a visible grain, each leaf is unique. Shades can even vary in individual parts of the same door. This is particularly noticeable in the case of doors covered with a knotty veneer, which we cannot use for band trims. In these places, the veneer is similar to the leaf, but does not have knots. This is nature - we take it as it is, with love.

As you browse through this catalogue, you will come across a range of advice and interesting facts about wooden doors, their nature, installation, maintenance, and characteristics. You can find more information about wooden doors on the www.prawdziwedrzwi.pl blog, in our podcasts, and on social media. We invite you to follow them and to buy real doors from CAL.



● Standard option ● Extra-cost option

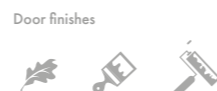



Geometry
Collection



Geometry Collection

Let us plunge right into geometry. Geometry is a key to unlocking the secrets of the Universe.

Twelve inspirational patterns, lacobel glass inlays and unconventional design. If you want to bring natural order into your interior – choose models from this collection! They are based on geometric concepts that have been created for contemporary indoor spaces.

Go for a single colour, satin finish without a visible grain of the wood (available in each RAL colour) or a clear varnish colour e.g. knotty oak. The lacobel glass inlay is flushed with the surface of the leaf which is a bow towards the top-of-the-range manufacturing standards and trends that have dominated the market. The standard price includes lacobel glass in the most popular colours: black, white and anthracite. For a small surcharge, you may choose any RAL colour which will match the décor of the living room or the entrance hall.

The Geometry collection is our response to the still-prevailing market trend which highlights contrasting combinations.



Horizontal 01

- Colour: RAL 9003 smooth painted
- Black lacobel glass inlays



Horizontal 02

- Veneer: Knotty oak
- Colour: WO 3032
- Black lacobel glass inlays

Horizontal 03

- Colour: RAL 9003 smooth painted
- Black lacobel glass inlays



Standard option Extra-cost option

Door type



Doorframe



Door structure



Door finishes



Door type



Doorframe



Door structure



Door finishes





Geometry Collection



Horizontal 04

- Colour: RAL 7045 smooth painted
- Ⓢ White lacobel glass inlays



Horizontal 12

- Ⓢ Colour: RAL 9003 smooth painted
- Ⓢ Black lacobel glass inlays



Vertical 01

- Ⓢ Colour: RAL 9003 smooth painted
- Ⓢ Black lacobel glass inlays



Horizontal 23

- Colour: 9005 X-matte smooth painted
- Ⓢ White lacobel glass inlays



Horizontal 13

- Ⓢ Colour: RAL 9003 smooth painted
- Ⓢ Black lacobel glass inlays

A reversible door with a reversed rebate

This is not only a solution to the problem of the door conflict. The functionality of some rooms means that some doors should open inwards while all others next to them open outwards. Reversible doors solve this aesthetic problem. Ask the seller to carefully analyse the height of the door and the trims so that on the corridor side the trims are at one level (Details: page 68).

Ⓢ Standard option ● Extra-cost option

Ⓢ Standard option ● Extra-cost option

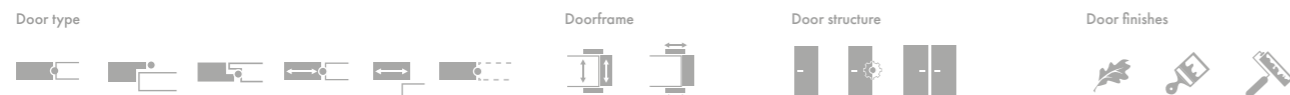



Geometry Collection



Vertical 02

- ⑤ Colour: RAL 9003 smooth painted
- ⑤ Black lacobel glass inlays



Vertical 11

- ⑤ Colour: RAL 9003 smooth painted
- ⑤ Black lacobel glass inlays



Vertical 31

- Ⓞ Colour: RAL 5014 smooth painted
- ⑤ White lacobel glass inlays



Vertical 21

- Ⓞ Colour: RAL 5003 smooth painted
- ⑤ White lacobel glass inlays

⑤ Standard option Ⓞ Extra-cost option

Single colour or the grain of the wood?

A smooth soft finish is a recurring fashion statement.

To achieve this effect on wooden doors, we cover their surface with a perfectly smooth panel and then paint them. Smooth surfaces are more difficult to maintain, so it is worth thinking about the X-matte coating, which eliminates this inconvenience. The visible grain is the domain of all clear finishes, highlighting the naturalness and genuineness of wooden doors. When painted with opaque paints, the naturalness of oak becomes visible in the form of natural „pores“ and small „craters“.

Door stops

If you want to avoid damaging the door or want to block it in a certain position, use various types of door stops. There are many such devices available on the market and they may come in the form of rag cats filled with sand, heavy discs placed on the floor or invasive elements fixed to the floor and wall. Our offer includes also an opening assistant installed in the leaf.

Watch the video to find out more!



⑤ Standard option Ⓞ Extra-cost option

Door type



Doorframe



Door structure



Door finishes



Door type



Doorframe



Door structure



Door finishes





Classic Collection



Classic Collection

The inspiration for the doors from the Classic collection was the everlasting beauty of the traditional interior design. Solid versions of the leaves in this collection are distinguished by rectangular grooves, displaying exceptional symmetry. The grooves may also be softened by an arched crowning. The glazing is arranged in two regular, simple rows which form a minimalist, sublime door decoration. The doors from this collection have a universal look so they invariably enjoy tremendous popularity.

The classic beauty of tradition. If you need a beautiful and yet functional decoration, matching any interior – the Classic collection is here.



Hańcza

Material: Oak
Colour: WO 3188



Szelment Option
oval-shaped curve in the top rail



Necko Option
curve-shaped arch in the top rail



Hańcza 4s

Material: Oak
 Colour: RAL 7037
 Frosted laminated glass



Szelment Option
oval-shaped curve in the top rail



Necko Option
curve-shaped arch in the top rail



Hańcza 6s

Material: Oak
Colour: Clear varnish
Frosted laminated glass



Szelment Option
oval-shaped curve in the top rail



Necko Option
curve-shaped arch in the top rail



Standard option Extra-cost option

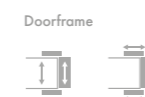



Hańcza 10s

- ⑤ Material: Oak
- Ⓞ Colour: RAL 9003
- ⑤ Frosted laminated glass



Szeliment Option
oval-shaped curve in the top rail



Necko Option
curve-shaped arch in the top rail

Kisajno 3s

- ⑤ Material: Oak
- ⑤ Colour: Clear varnish
- ⑤ Frosted laminated glass



Niegocin

- ⑤ Material: Oak
- ⑤ Colour: RS 05



Sajno

- ⑤ Material: Oak
- ⑤ Colour: WO 3073



Kisajno

- ⑤ Material: Oak
- Ⓞ Colour: RAL 5003

⑤ Standard option Ⓞ Extra-cost option

⑤ Standard option Ⓞ Extra-cost option

Bathroom door, wall thickness

Take the thickness of the tiles into account when measuring the wall thickness at the height of the bathroom door. If the tiles are not laid all the way up, make sure that the frame bands rest evenly on the wall.

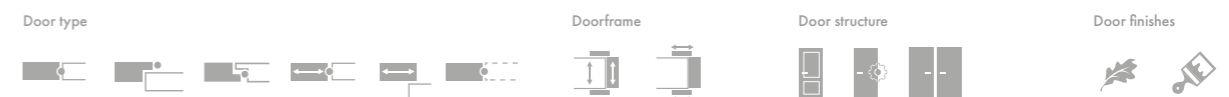
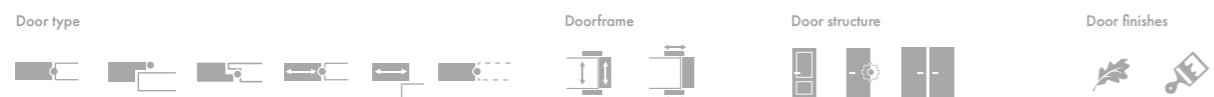



Szurpity

- Material: Oak
- Colour: RAL 9003



Szurpity 5p

- Material: Oak
- Colour: SS 261



Szurpity 2s

- Material: Oak
- Colour: RAL 7016
- Frosted laminated glass



Szurpity 6p

- Material: Oak
- Colour: WO 3188

When to install an interior door – the first piece of furniture in a house?

Interior doors should be treated as the first piece of furniture in the house. Install them as late as possible, after the walls, ceilings and floors are all painted and ready. The dust present during the interior works does not do your beautiful new doors any good. In addition, it's hard to monitor all the professionals working at this stage. Once they go, it's the right time for the door installation team and your dream doors to enter.

A rebate and a rabbet

Properly shaped edges of the leaf and the doorframe, in which seals, a lock, sometimes hinges (the concealed ones) and a blockade are placed. Thanks to such shaping of the edges the door leaf fits exactly into the doorframe.

Standard option Extra-cost option

Standard option Extra-cost option

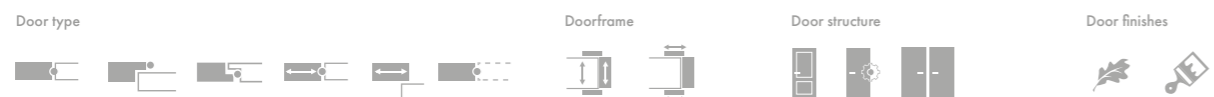



NOVA 3.0
Collection



NOVA 3.0 Collection

Wood a la mode. Create a unique focal point with the Nova 3.0 collection. Open your mind to a creative, rarely encountered and even unconventional way of decorating.

The Nova 3.0 collection changes the standard way of thinking about the design of interior doors, both panel door and glazed door. Doors from this collection are a great find for original interiors which diverge from classic standards. The uniform surface of the leaves is diversified by untypical glazing featuring sophisticated, elongated shapes.

The Nova 3.0 collection means also a wide range of colours to match the strong details of your home décor. It includes oak doors based on a frame and panel structure (a shaker style interior door). The glazing is durable and safe, and it is flushed with the surface of the leaf which adds charm to the final outcome.

If you are looking for the latest designs and at the same time want to enjoy the everyday touch and the beauty of wood – the Gremzdy and Okmin models will be your best choice.



Gremzdy 1s

- Material: Oak
- Colour: WO 3188
- Frosted laminated glass



Gremzdy

- Material: Oak
- Colour: SS 261

Gremzdy 11

- Material: Oak
- RAL 9005 X-matte
- Frosted laminated glass



Standard option Extra-cost option

Door type



Doorframe



Door structure



Door finishes



Door type



Doorframe



Door structure



Door finishes





NOVA 3.0
Collection



Gremzdy 15

- Material: Oak
- Colour: Clear varnish
- Frosted laminated glass



Gremzdy 23

- Material: Oak
- Colour: WO 3032
- Frosted laminated glass



Gremzdy 12

- Material: Oak
- RAL 9005 X-matte
- Frosted laminated glass



Gremzdy 25

- Material: Oak
- Colour: WO 3161
- Frosted laminated glass

Sliding pocket door

Mounted in the wall, the leaf is invisible when fully opened and does not take up any space on the wall surface. The metal structure is adapted to an at least 125 mm thick drywall. The doors can be single, double or telescopic. Note that the cassette and the leaf must fit together.

CAL standard leaves are 2,017 mm high.

Eco-friendly paints and oils

CAL doors are finished with environmentally friendly water-based paints or oils, which is important if household members are prone to allergies.

Standard option Extra-cost option

Standard option Extra-cost option

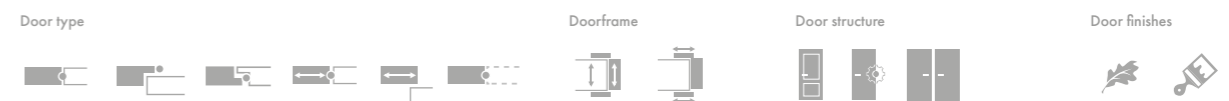
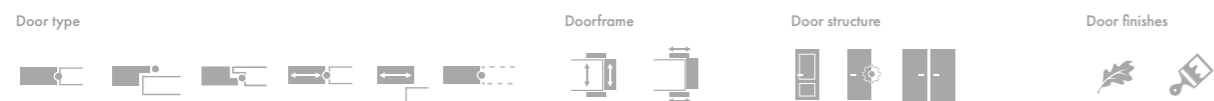



Okmin

- ⑤ Material: Oak
- ⑤ Colour: WO 3188



NOVA 3.0
Collection



Okmin 1p

- ⑤ Material: Oak
- ⑤ Colour: Clear varnish
- ⑤ Frosted laminated glass

Okmin 1s

- ⑤ Material: Oak
- ⑤ Doorframe colour: RAL 9005 X-matte
- ⑤ Leaf colour: RAL 9003
- ⑤ Frosted laminated glass



Okmin 3p

- ⑤ Material: Oak
- ⑤ Colour: RAL 9003
- ⑤ Frosted laminated glass

Floor transition

When laying the floors, it is worth considering the position of the door. With good planning, a closed leaf will cover the joining of two different floors.

Jamb

A vertical element in a window or a door opening obtained by extending bricks for brick walls or by adding vertical posts for wooden or stone walls. It provides support for the doorframe. It should be noted, however, that it is required for adjustable doorframes to install them in a non-invasive way. A jamb is an element that will allow you to install the doorframe bands without having to cut them. The 80 mm wide bands overlap the wall by approx. 35mm with an installation gap of 15mm (Figures: Page 65).

⑤ Standard option ⑥ Extra-cost option

⑤ Standard option ⑥ Extra-cost option

Door type



Doorframe



Door structure



Door finishes



Door type



Doorframe



Door structure



Door finishes





Luxury
Collection



Luxury Collection

Interior doors from the Luxury collection are the sheer quintessence of timeless, elegant design. Their diversified versions – panel, partially or fully glazed – enable easy pairing of their appearance with the function of the room. Straight or arched wood trims on the surface of each model create a simple decoration that can go perfectly well with various interior arrangement styles. The leaf's structure is 100% made of oak.

The Luxury collection brings you timeless beauty that adds splendour to both classic style houses and contemporary spaces in which tradition and modernity create a harmonious duet.



Arabeska

Material: Oak
Colour: SS 103



Arabeska 1s

Material: Oak
 Colour: WO 3188
 Frosted laminated glass



Arabeska 10s

Material: Oak
Colour: WO 3188
Frosted laminated glass

Standard option Extra-cost option

Door type



Doorframe



Door structure



Door finishes



Door type



Doorframe



Door structure



Door finishes





Opera

- Material: Oak
- Colour: RS 16



Luxury
Collection



Tango 02

- Material: Oak
- Colour: WO 3168



Opera 9s

- Material: Oak
- Colour: RAL 9003
- Frosted laminated glass



Tango 03

- Material: Oak
- Colour: RS 10



Opera 15s

- Material: Oak
- Colour: Clear varnish
- Frosted laminated glass

Standard option Extra-cost option

Standard option Extra-cost option

Bathroom door, wall thickness
Take the thickness of the tiles into account when measuring the wall thickness at the height of the bathroom door. If the tiles are not laid all the way up, make sure that the frame bands rest evenly on the wall.

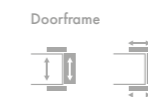
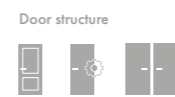
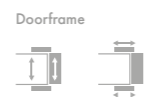



Tango 04

- Material: Oak
- Colour: RS 16



Luxury
Collection



Tango 14

- Material: Oak
- Colour: RAL 9005



Tango 13

- Material: Oak
- Colour: RS 12



Tango 23

- Material: Oak
- Colour: WO 3188

Standard option Extra-cost option

Bathroom doors, ventilation vents

The required ventilation area is derived from the ventilation design of the house. The design foresees the pressure difference between the rooms, their cubic capacity, the air exchange rate in a certain time, and based on these data indicates the ventilation surface in the door. What counts are the ventilation holes in the leaf and the area between the suspended leaf and the floor. A standard 80 leaf is hung at a height of 8 mm, which results in a ventilation area of 64 cm², while the ventilation vent for a CAL door has an area of approx. 54 cm² (by way of comparison, one ventilation duct with a 40 mm diameter has an area of approx. 12 cm²). The remaining value required by the design should be derived from the ventilation undercut. View page 62.

Standard option Extra-cost option

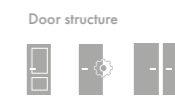
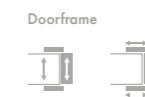
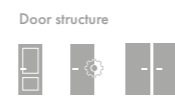
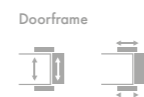
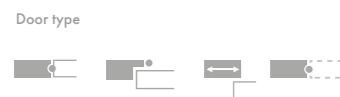

Colours



Oak
CAL 110

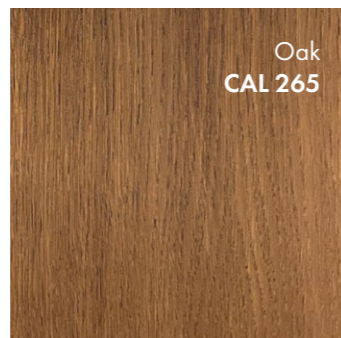

Oak
CAL 265

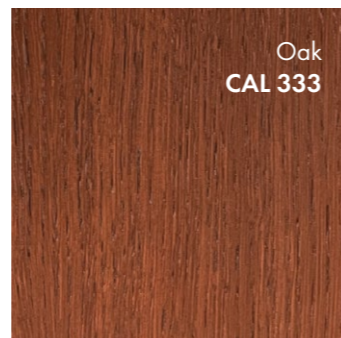

Oak
CAL 333



Oak
CAL 831

All varnishes are water-based, and, therefore, environment- and user-friendly. Upon request, we may also apply wax oils (WO).

Oils penetrate the structure of wood by filling its pores and protect it against the adverse impact of water.

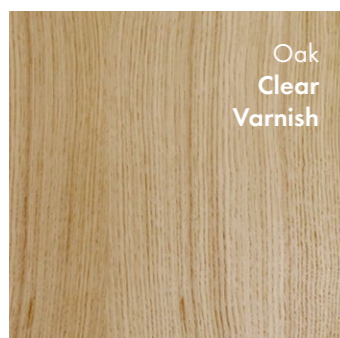

Oak
Clear
Varnish



Oak
RS 01



Oak
RS 05

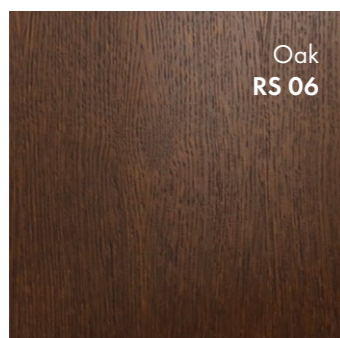

Oak
RS 06

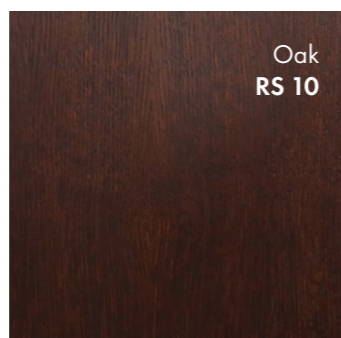

Oak
RS 10

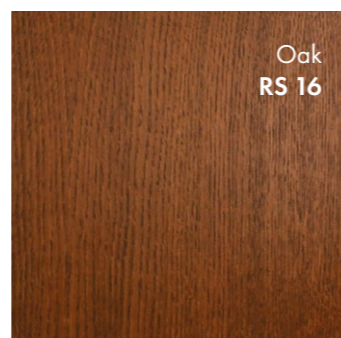

Oak
RS 16

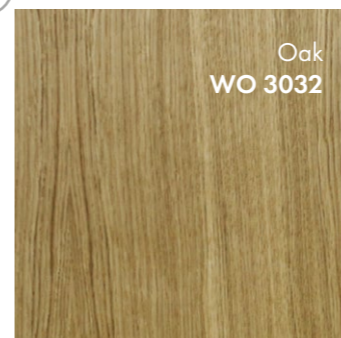

Oak
WO 3032

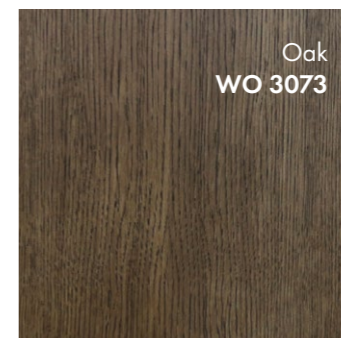

Oak
WO 3073



Oak
WO 3119

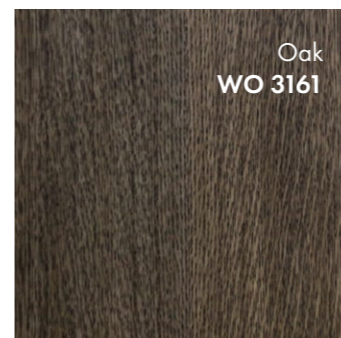

Oak
WO 3161



Oak
WO 3168
Knotty

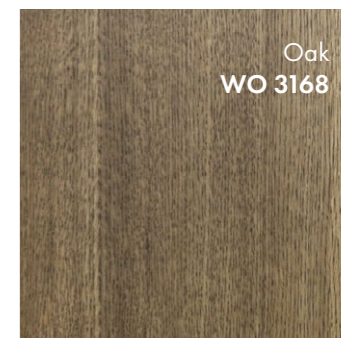

Oak
WO 3168



Oak
WO 3188
Patina



Oak
WO 3514

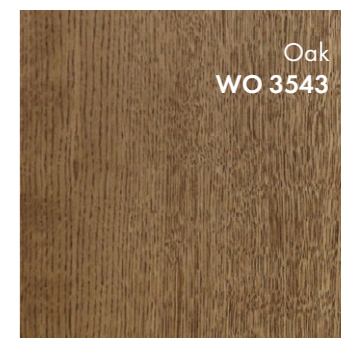

Oak
WO 3543



Colour
RAL/NO.



Colour
RAL 9003

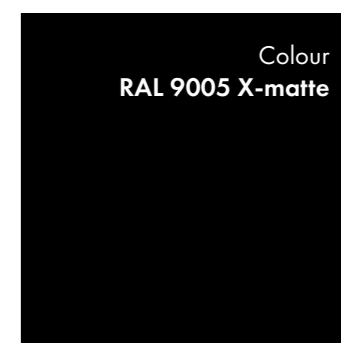

Colour
RAL 9005 X-matte

Handles

- Simple and fast installation!
Doors can come with holes for handles.
Pre-drilled holes for handles are included in the price of the handle.
Now, anyone in just a few minutes will mount a handle. No drilling, no tools. A screwdriver is the only thing you need.

A handle – door jewellery

An immense choice of handles and grips, or, as we like to call it, door jewellery that is available on the market is truly astounding. Our customers will choose according to their preferences. Our offering includes handles carefully hand-picked for each collection.

NOVA 3.0

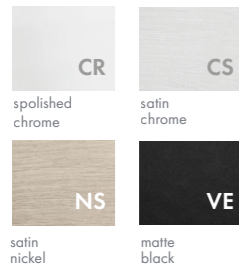

Escutcheons



Key hole Euro-profile Privacy set

LUXURY

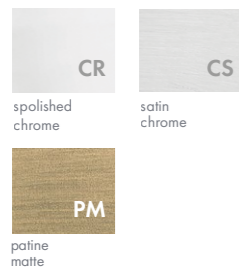

Escutcheons



Key hole Euro-profile Privacy set

CLASSIC

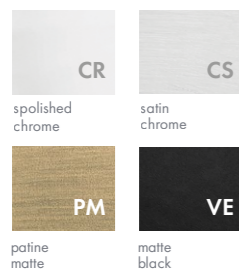

Escutcheons



Key hole Euro-profile Privacy set

LA LINEA 2

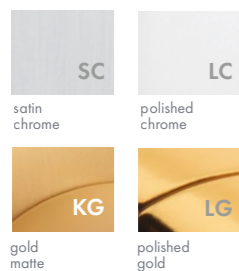

Escutcheons



Key hole Privacy set



*The pre-drilled hole standard

OP-ART

Dostępna w kolorach:



Handle



Handle with a privacy set



Handle



Handle with a privacy set

APRILE

FITTINGS FOR SLIDING SYSTEMS



Scivola Tre Lock

A lock with pulls (key, privacy set, lock cylinder)

Available in the following colours:



AGB
Open, Close, Live



Pull

Available in the following colours:



AGB
Open, Close, Live



Pull 2650

Available in the following colours:
VE, CR

HINGE COVERS

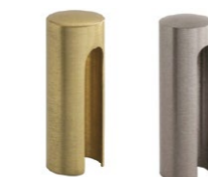

BRASS

Available in the following colours:
CS, CR, PM, NS



DECORATIVE BRASS

Available in the following colours:
CR, PM



NYLON

Available in the following colours:
BLACK, WHITE

Hinges



CONCEALED HINGE for non-rebated door

- A concealed hinge for a non-rebated leaf
- 3D adjustment
- CR, black or white
- White is unavailable in RETRO doorframes
- Hinge covers included



LIFT OFF PIN HINGE for rebated door

- Strong and reliable screwless lift off pin hinges for rebated door type
- 3D adjustment
- Galvanized finish
- Hinge covers not included (view page 59)

Loks

In all our doors a magnetic lock is a standard option.

Available in the following colours:
white, black, gold

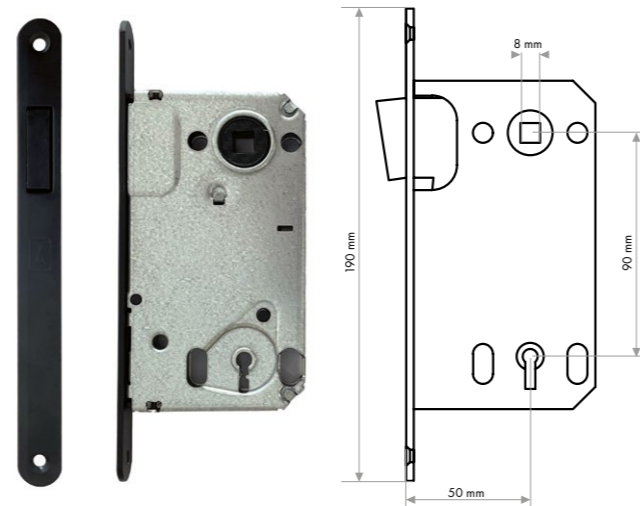

Key-operated lock

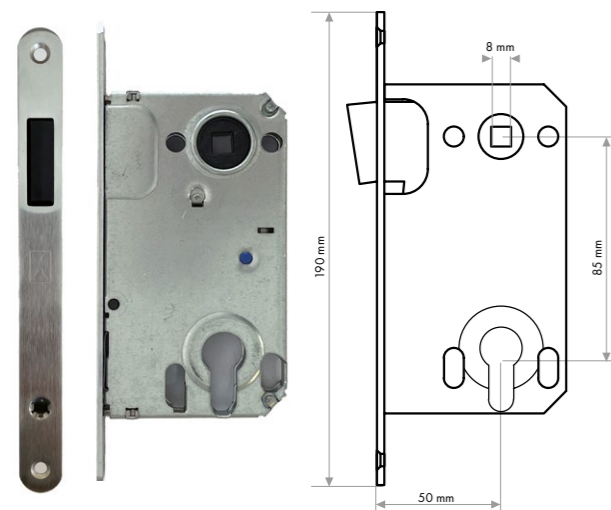

Cylinder-operated lock

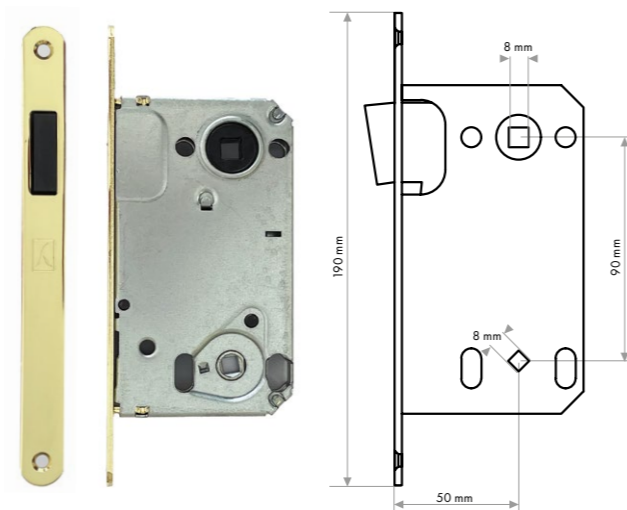

Privacy set lock

Glazing

For surcharges view p. 78



Beveled glass
Reflective Bronze
Privacy Level 1



Beveled glass
Reflective Graphite
Privacy Level 1



Laminated glass
Clear
Privacy Level 0



Beveled glass
Clear
Privacy Level 0



Beveled glass
Acid-etched
Privacy Level 4



Laminated glass
Frosted
Privacy Level 5



Toughened glass
Acid-etched
Privacy Level 4

Door structure

Nature in your house

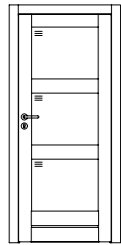

CAL interior door – a frame & panel door structure

- a frame made of multilayer oak wood
- infilled with safe glass or a panel
- a ventilation vent
- tinted or painted oak



Door type: Non-rebated, rebated, reversible, sliding, or with frameless door

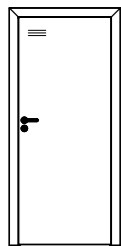

CAL interior door – a flush door structure with a solid wood core

- a uniform slab on the entire surface
- solid wood door or low density fibreboard door
- a ventilation cut (optional)
- tinted or painted oak
- tinted knotty oak
- painted/single colour



Door type: Non-rebated, rebated, reversible, sliding, or frameless door

Selected Work



1/67



2/67



3/67



5/67



6/67



4/67



8/67

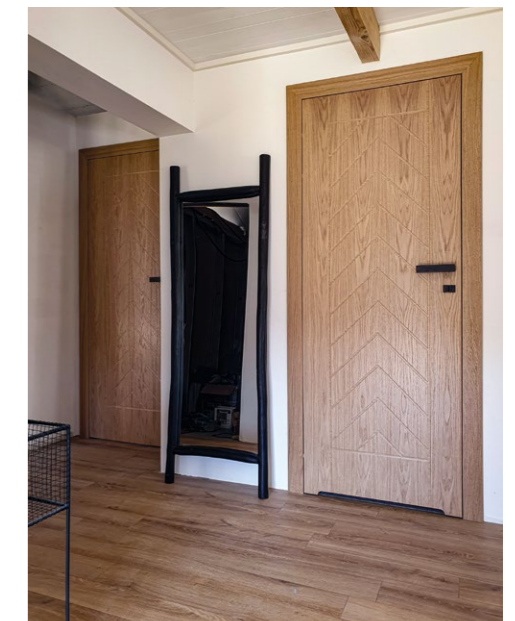

9/67



7/67

Doorframes

For higher doors we apply 4 hinges.

1. Basic adjustable doorframe



2. Adjustable doorframe with a crown moulding and a decorative trim



3. Rebated doorframe with a masking trim



4. Adjustable doorframe with a top panel



5. RETRO adjustable doorframe with a decorative trim



6. RETRO adjustable doorframe with a crown moulding and decorative trim



7. Adjustable doorframe with bottom plinths



8. Adjustable doorframe with a washboard and a crown moulding

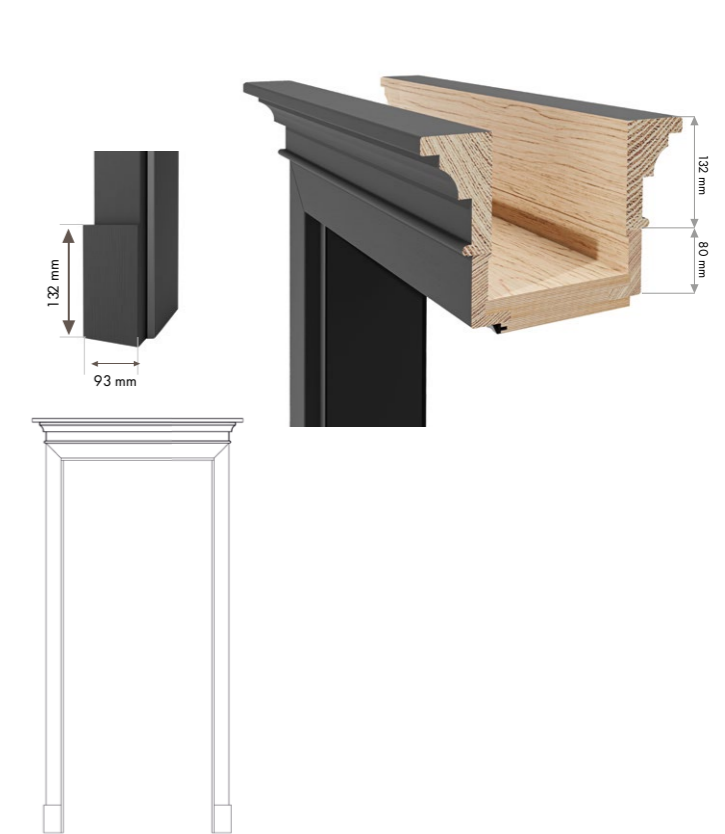

In higher doors we apply 4 hinges.

Doors over 2200mm high come with four hinges.

Doorframes

Important: The depth of the doorframe does not affect the price within a specified range. Non-standard doorframes are available at an extra cost.

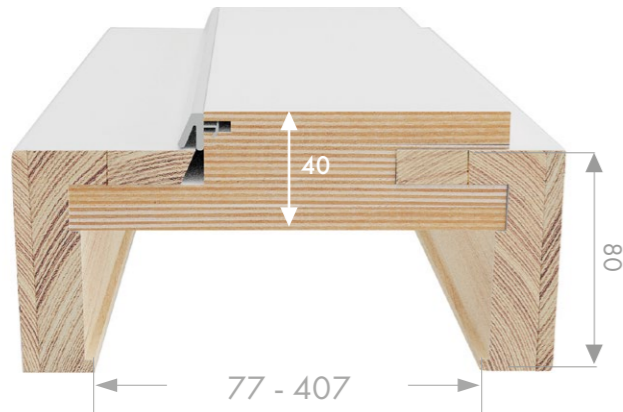

Adjustable doorframe SOFT

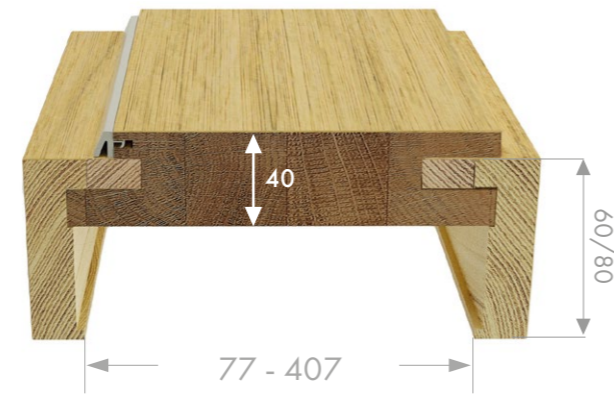

Adjustable doorframe PREMIUM

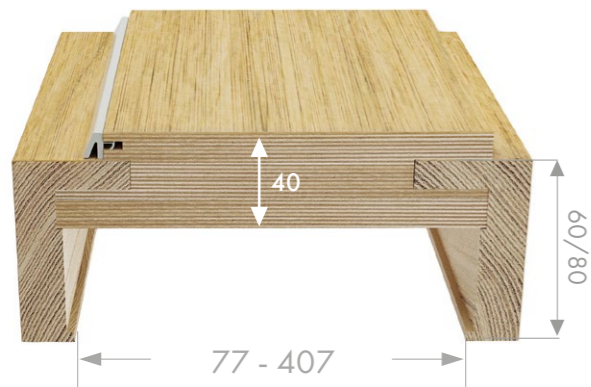

Adjustable doorframe BASIC



Rebated doorframe

Concealed doorframe

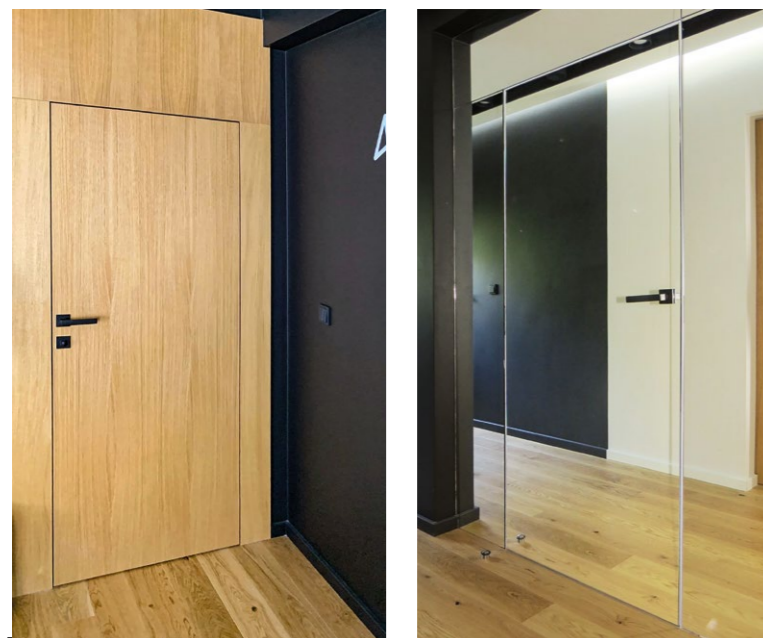

Doorframe concealed in a wall Eclisse

A concealed doorframe with an aluminium rebate visible when the door is open.

Sliding door



POCKET DOORS (single and double)

A perfect solution that helps to save some space. Since the door is hidden in the wall the space around it can be used for other purposes.

Size	Leaf width	A	B	C
G 90	943	926	970	1946
GG90	943+943	1846	1890	3810
G80	843	826	870	1746
GG80	843+843	1646	1690	3410
G70	743	726	770	1546
GG70	743+743	1446	1490	3010

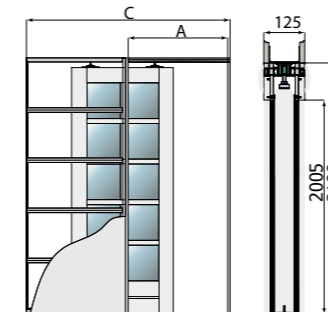
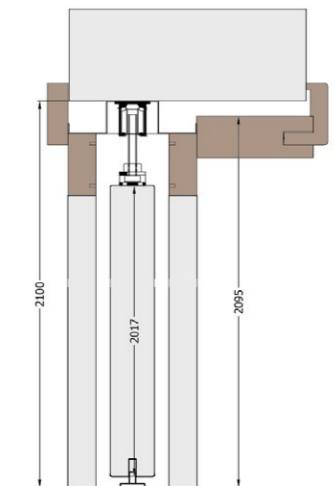

SINGLE POCKET DOOR
for dry walls

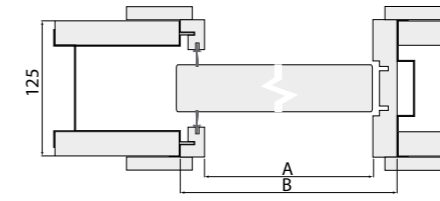

SINGLE POCKET DOOR
wall mounted with a top mounting track

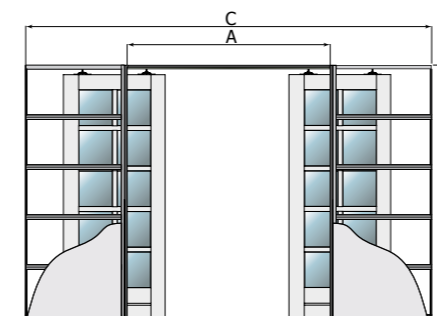
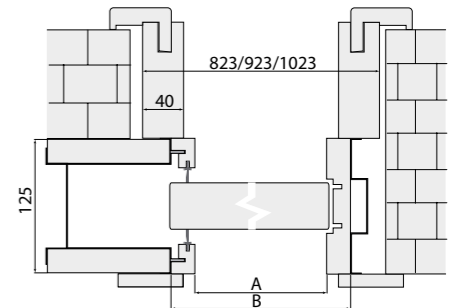

DOUBLE POCKET DOOR
for dry walls

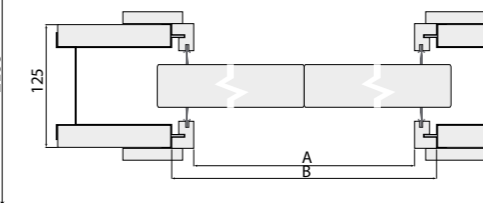

DOUBLE POCKET DOOR
wall mounted with a top mounting track

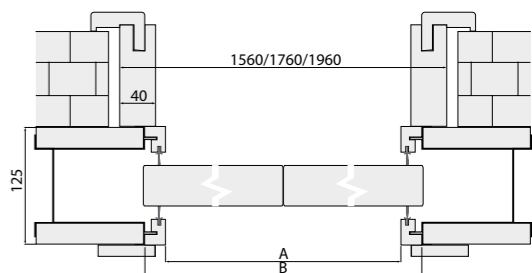



SLIDING DOOR wall mounted track

The CAL system. Elegant and convenient. The wooden built-up system is visible but does not occupy any more space than it is necessary. By the same token, it underlines the individual style of the interior.

Size	Leaf width	So	Sz	L	Sop*
90	943	1000	980	1965	60-1004 / 80-1084
2x90	943+943	1920	1902	3782	60-1966 / 80-2006
80	843	900	880	1765	60-944 / 80-984
2x80	843+843	1720	1702	3382	60-1766 / 80-1806
70	743	800	780	1565	60-844 / 80-884
2x70	743+743	1520	1502	2982	60-1566 / 80-1606

Single Wall-Mounted Sliding System

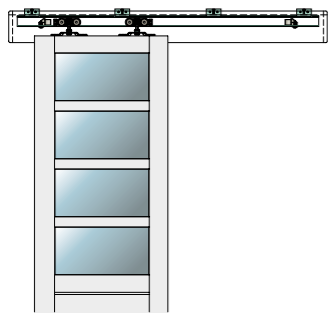

Double Wall-Mounted Sliding System

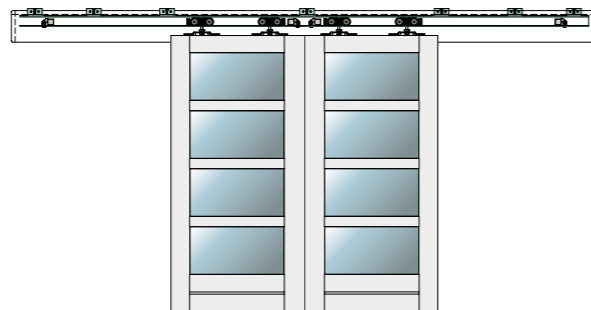

Wall-Mounted Sliding System

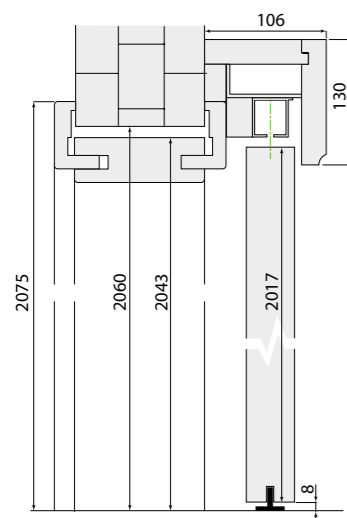

Single Wall-Mounted Sliding System

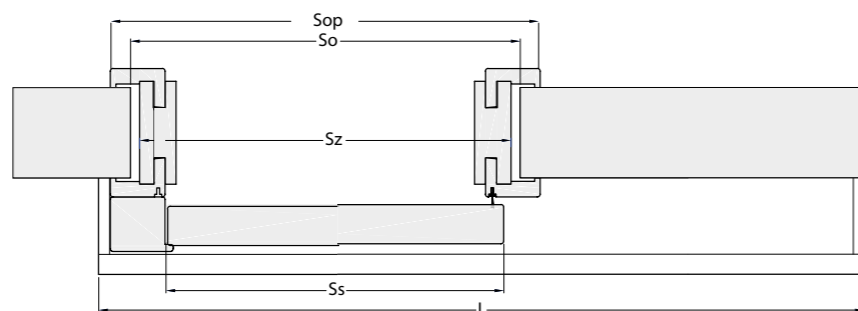

ERGON DOOR SYSTEM

Amazing and unique, the Ergon door system allows for simple access from either side of the door and simply swings to the side sharing the width of the door between two rooms. Perfect for smaller accommodation types.

Convenient to install in rooms where the partition walls are not perpendicular to each other. The minimum required width of the wall is 140 mm.



Check out how it works !



LAGUNA SYSTEM

Heavy Duty Sliding Barn Door Hardware Kit. Trendy option for loft, cottage, or any other interiors.

The package includes: Rail, Rail Spacers, Rollers, Door Stops, Anti-jumpers, and Floor Guide. **THE DOOR IS NOT INCLUDED.**

Door Weight Capacity: 100kg

Sizes: 2m, 2.5m, 3m. Can be multiplied in length by joining tracks.

Hanger options



The Reversible System



Standard swing system:

A leaf flushed with a doorframe, opening outwards



Reversible swing system:

A leaf flushed with a doorframe, opening inwards
 Note: In the Noble Collection one side cannot contain a inlay.

Heights of traditional and reversible doors

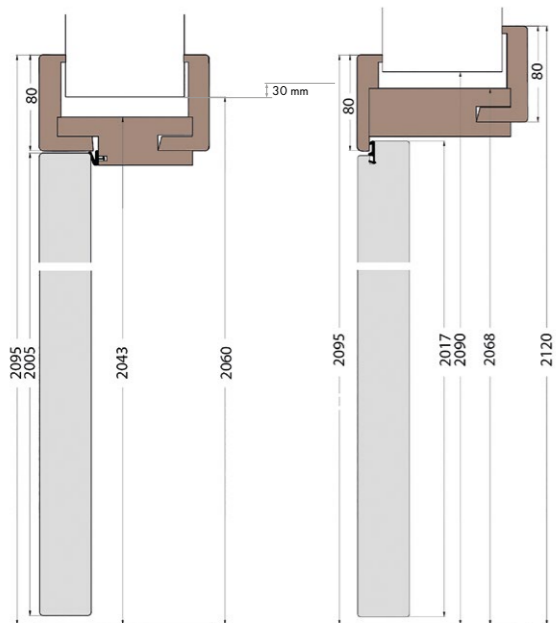

Directions of opening reversible doors

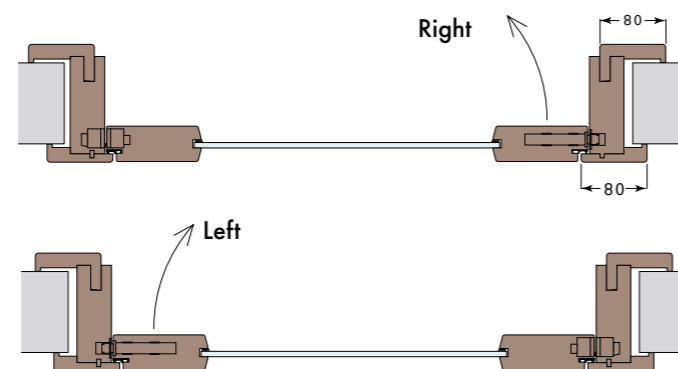

❶ A door with a smooth finish is also available in the reversible version.

Width of reversible doors

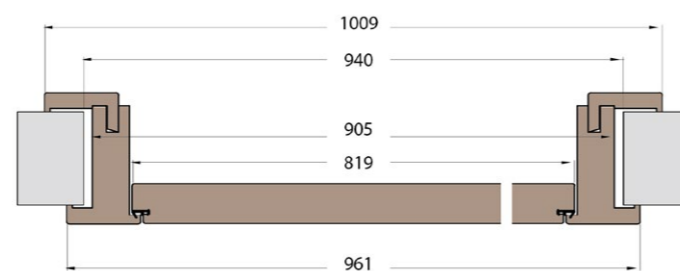

Door restrictor (Extra-cost option)



Protects against door damage when the door is opened wide.

❶ The door restrictor can be heard as the door opens.

Still more nature



Knotty oak veneer

Nature's beauty and its uniqueness are best conveyed by a knotty oak veneer, aka "wild oak". The natural knots and grain of the wood create character and charm.

❶ NOTE! Knots can break out of the sheets due to subsequent drying of the wood and manipulation of the veneers, creating an open defect. For this reason, we fill the defects with black glue, in the same way as the cracks, to achieve aesthetic colouring with a depth effect. The size of these open defects is undefined and, in rare cases, can be several centimeters in diameter.

Ideal matching



Each door is made-to-measure, especially for you. It will go through a meticulous process of picking the best wood. It will be transformed into a product that will decorate your interior.

Once you pick a door made of real wood, you get a healthy microclimate at your home for free.



You haven't found the ideal door yet?

❶ This catalogue serves merely as an inspiration. Passive leaves, double doors, sliding doors are all there to enable the best use of space in your house.

Get inspired! View our work and products at www.drzwi-cal.pl/en

Door Size Guide

Adjustable doorframe
(rebated door)

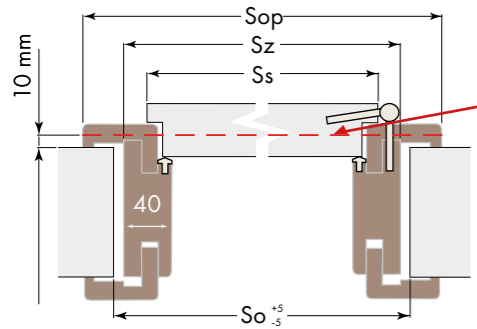

Adjustable doorframe
(non-rebated door)

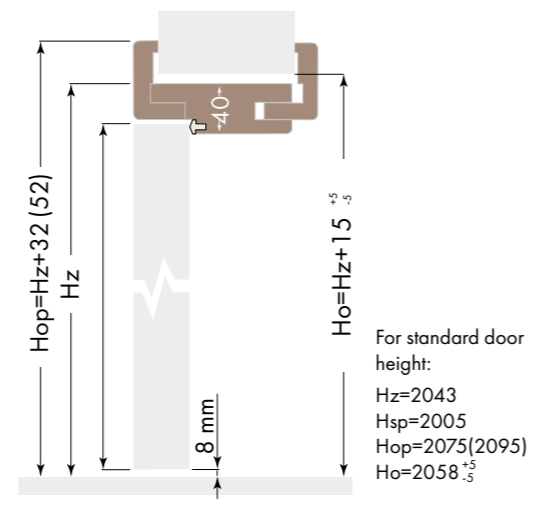
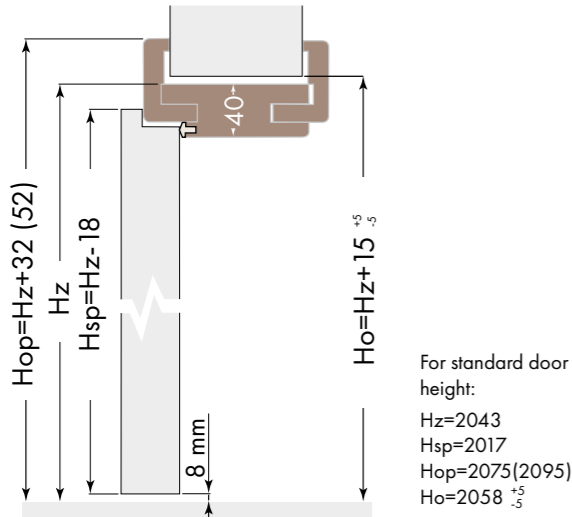
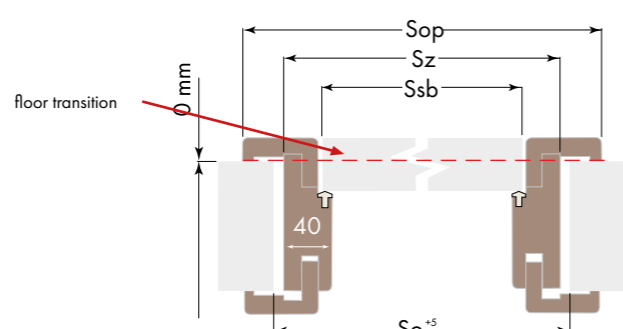

Doorframe with a panel

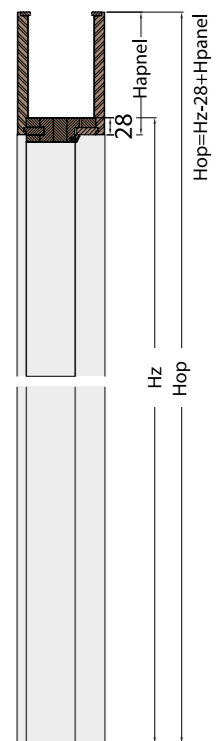

Rebated doorframe

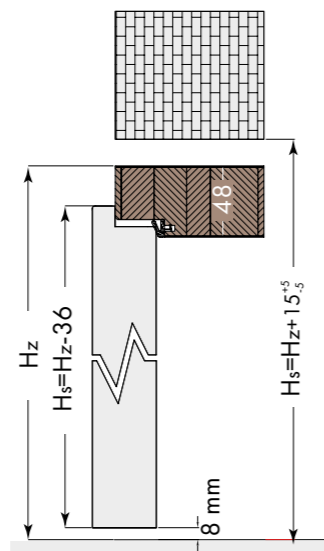
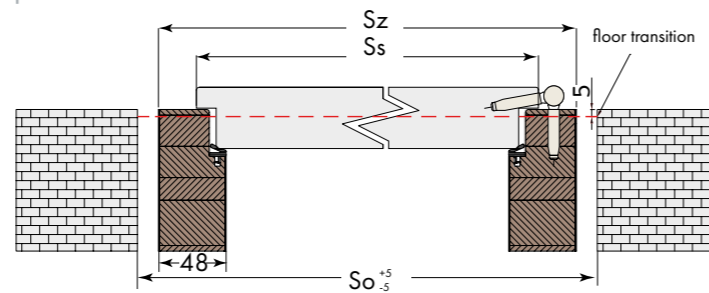

	Model	LEAF		REBATED DOORFRAME		ADJUSTABLE DOORFRAME				
		Ss	Ssb	Sz	So	Sop 60	Sop 80	Sz	So	
SINGLE	OP-ART LA LINEA GEOMETRY NOVA 3.0 NOVA 3.1 LUXURY CLASSIC NOBLE LOFT	90	943	919	997	1027	1044	1084	980	1010
		80	843	819	897	927	944	984	880	910
		70	743	719	797	827	844	884	780	810
DOUBLE	OP-ART LA LINEA GEOMETRY NOVA 3.0 NOVA 3.1 LUXURY CLASSIC NOBLE LOFT	2x90	2x943	2x931	1928	1958	1978	2018	1914	1944
		2x80	2x843	2x831	1728	1758	1778	1818	1714	1744
		2x70	2x743	2x731	1528	1558	1578	1618	1514	1544
WITH 1/2 PASSIVE LEAF	OP-ART LA LINEA NOVA 3.0 NOVA 3.1 CLASSIC (Hańcza, Kisajno, Niegocin, Sajno) LOFT	90+1/2	943+579	931+567	1564	1594	1615	1655	1550	1580
		80+1/2	843+529	831+517	1414	1444	1464	1504	1400	1430
		70+1/2	743+479	731+467	1264	1294	1314	1354	1250	1280
WITH 1/2 PASSIVE LEAF	LUKSUSOWA (Menuet, Arabeska)	90+1/2	943+612	931+600	1597	1627	1647	1687	1583	1613
		80+1/2	843+562	831+550	1447	1477	1497	1537	1433	1463
		70+1/2	743+512	731+500	1297	1327	1347	1387	1283	1313
WITH 1/2 PASSIVE LEAF	LUXURY (Tango)	90+1/2	943+536	931+524	1521	1551	1569	1609	1505	1535
		80+1/2	843+486	831+474	1371	1401	1419	1459	1355	1385
		70+1/2	743+436	731+424	1221	1251	1269	1309	1205	1235
WITH 1/2 PASSIVE LEAF	LUXURY (Opera)	90+1/2	943+502	931+490	1487	1517	1537	1577	1473	1503
		80+1/2	843+469	831+457	1354	1384	1404	1444	1340	1370
		70+1/2	743+436	731+424	1221	1251	1271	1311	1207	1237
WITH 1/2 PASSIVE LEAF	CLASSIC (Szurpily)	90+1/2	943+536	931+524	1522	1552	1570	1610	1506	1536
		80+1/2	843+486	831+474	1372	1402	1420	1460	1356	1386
		70+1/2	743+436	731+424	1222	1252	1270	1310	1206	1236
WITH 1/2 PASSIVE LEAF	NOBLE	90+1/2	943+562	931+550	1548	1578	1596	1636	1532	1562
		80+1/2	843+512	831+500	1398	1428	1446	1486	1382	1412
		70+1/2	743+462	731+450	1248	1278	1296	1336	1232	1262

Door size guide: door width *

*) for height view figures next to the table

	REBATED DOORFRAME	ADJUSTABLE DOORFRAME
Doorframe height Hz	2052	2043
Opening height Ho	2067	2058

	OP-ART	GEOMETRY	NOVA 3.0 / LOFT	NOVA 3.1	LA LINEA	LUXURY	CLASSIC	NOBLE
Notes	Leaf available only in the OW-3032 colour; doorframe in the standard X-Mat 9005, OW-3032 (standard option)			Ergon system and reversible system, excluding the Jaczno model		Solid door Glazed door Chamfered glass, excluding the Arabeska 10 s model	Without glazing bars With glazing bars	
Painting/ Knotty veneer								
RAL/NCS on oak	N/A		O		S		O	
RAL 9003 smooth finish	N/A	S	N/A	O	S		N/A	S
RAL/NCS other than 9003 smooth finish	N/A	O	N/A	O	S		N/A	O
CAL colour on oak (CAL, RS, WO)	N/A		S			S		O
CAL bicolour (CAL, RS, WO)	N/A				O			O
RAL/NCS bicolour	N/A				O			
The knotty veneer on a leaf (unavailable for a doorframe)	N/A	O	N/A	O			N/A	
9005 X-matte/other (a surcharge applies for RAL)	S (doorframe)		O		S/O		O	
Doorframe in a different colour than the leaf					O			
NON-STANDARD DIMENSIONS								
Non-standard width between 680/780 and 1,080 mm			O			O	O	
Non-standard height between 2,000 and 2,200 mm			S			O	S	S
Non-standard height between 2,201 mm and 2,500 mm					O			
Height below/under 2,000 mm			O			O	O	
Opening systems								
Double door or with a 1/2 and 1/3 passive leaf					O			
Single wall-mounted sliding system				O				N/A
Double wall-mounted sliding system				O				N/A
Single sliding system for a 125 mm dry wall				O				N/A
Double sliding system for a 125 mm dry wall				O				N/A
Tunnel (blind doorframe) for a sliding system for a 125 mm dry wall			O			nd	O	N/A
ERGON system. Available for a minimum wall width of 140 mm					2247,00			
Doorframe hidden in the wall			O			O	O	O
Reversible door			O					
GLAZING								
Frosted laminated glass	N/A	N/A	S	N/A	N/A	N/A	S	
DECORMAT tempered glass	N/A	N/A	N/A		S		N/A	
Lacobel glass inlay: RAL, black, anthracite, white	N/A	S	N/A				N/A	
Lacobel glass inlay: RAL, other colours	N/A	100,00	N/A				N/A	
OTHER								
Drop-down seal DRS 1530 50dB					O			
Drop-down seal CHRONOSEAL 52dB					O			
Quarter round					O			
Leaf cutting/Ventilation undercut					O			
Ventilation vent	N/A	N/A	S	N/A		S		N/A
Blinding of the ventilation vent	N/A	N/A	O	N/A			O	
Fittings kit: black/white/gold In hinges for retro doorframes casings are available only in chrome					O			
CAL standard pre-drilled handle hole* *standard pre-drilled handle hole					O			



CAL real doors

ZSB CAL Z. Cywiński i wspólnicy spółka jawna

ul. Piaskowa 5, 16-400 Suwałki, POLAND

Phone +48 87 563 11 55

biuro@drzwi-cal.pl

www.drzwi-cal.pl



GO EKO!



DON'T THROW AWAY THIS CATALOGUE.

Pass it on to your neighbour who also needs a good door!

If you have to dispose of this catalogue, make sure it can be recycled.

Throw it in a blue paper bin.

REMEMBER! Coated or plastic-covered paper from advertising brochures is not recyclable, so it should be disposed of with mixed waste.

This publication has been valid since September 1, 2023. The information contained in the catalogue does not constitute an offer within the meaning of the Civil Code. You are choosing wood which is a natural material. Due to the printing technology, the colours shown may differ from the actual ones. Differences in finish, grain, and structure give the original and unique character of wood, which is a natural material and cannot be the basis for a complaint. They create a unique character of the natural raw material that wood is. The illustrations, technical information, data, and descriptions contained in this publication were accurate at the time of going to print. We reserve the right (without prior notice) to make changes to the dimensions, technical parameters, equipment, and improvements of the products presented herein, arising from our continuous efforts to pursue improvement and development. Although every effort has been made to ensure that this publication contains complete and accurate information, we cannot be held accountable for any omissions or inaccuracies that may have appeared in it. The retail prices in this catalogue are average market prices for products in basic colours with standard equipment. The present catalogue does not set prices. All retail prices are given in Polish zloties (PLN net). The errors in the prices given in this catalogue cannot serve as a basis for any claims, including legal claims. Prior to the installation of the door, it is required that you get acquainted with the installation instructions. Important: CAL products are manufactured and equipped according to an individual order submitted by a consumer.

© Copyright CAL Real Doors